



Faculty of
Science and
Technology
Tokushima University

Global Asymptotics of the Painlevé equations

Professor Yousuke Ohyama

Elliptic Asymptotics of the first Painlevé equations

$$y'' = 6y^2 + x$$

$$y(x) \sim |x|^{1/2} \varphi \left(\frac{4}{5} e^{i\varphi} |x|^{5/4} - t(\varphi, s); g_2(\varphi), g_3(\varphi) \right) + O(|x|^{3/4}),$$

$$t(\varphi, s) = \frac{1}{2\pi i} \left(\omega_a(\varphi) \log(is_{2-2k}) + \omega_b(\varphi) \log \frac{s_{5-2k}}{s_{2-2k}} \right)$$

$$x \in D_k(\varphi, \varepsilon, s) = \left\{ x \in \mathbb{C}; \frac{(3+2k)\pi}{5} + \varepsilon \leq \varphi \leq \frac{(5+2k)\pi}{5} - \varepsilon \right\}$$

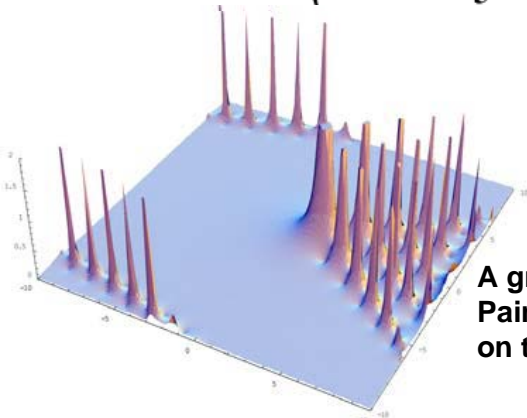

A graph of the first Painlevé transcendent on the complex domain

Paul Painlevé (left) was a former prime minister of France. He is the first mathematician who flew on the airplane. He was a passenger of Wilber Wright (right) on 1908.

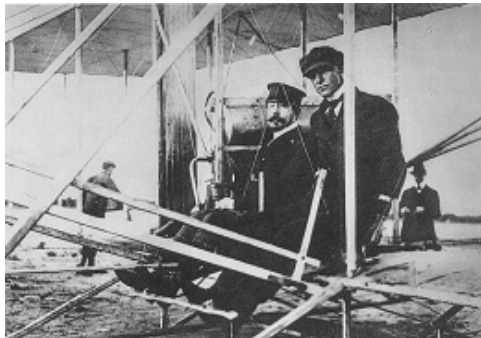

Content:

It is important to study **connection problems** of solutions of differential equations between two points in many fields of mathematical sciences. The global study on ordinary linear differential equations is still developing.

Paul Painlevé studied nonlinear differential equations with second order, which have **no movable branch points** (so called **the Painlevé property**). He and his pupil, Gambier, classified all of such equations in six types around 1900. Many nonlinear equations appeared in physics has the Painlevé property, and we can solve connection problems on such equations. We expect that the **Painlevé equations** play the same important role in nonlinear analysis as the Bessel functions or hypergeometric functions play in linear equations. The Painlevé equations are also obtained by **monodromy preserving deformations**. We can show the correspondence between global data of linear equations and local data of the Painlevé functions and we can study nonlinear connection problems or the nonlinear Stokes phenomenon on the Painlevé differential or difference equations.

Keywords : Classical Analysis, the Painlevé equations, monodromy problems

E-mail: ohyama@tokushima-u.ac.jp

Tel. +81-88-656-7541

Fax: +81-88-656-7541

HP: http://math0.pm.tokushima-u.ac.jp/~ohyama/index_e.html





Mathematical Analysis of Nonlinear Phenomena

Professor Kosuke Ono

1. Linear Dissipative Wave Equation:

$$\begin{cases} (\square + \partial_t)u = 0 & \text{in } \mathbb{R}^N \times (0, \infty) \\ (u, \partial_t u)|_{t=0} = (u_0, u_1) & \text{in } \mathbb{R}^N \end{cases}$$

[Energy Decay in Energy Spaces]

$$(u_0, u_1) \in H^1(\mathbb{R}^N) \times L^2(\mathbb{R}^N)$$

$$\Rightarrow E(u(t), \partial_t u(t)) \leq C(1+t)^{-1}$$

[Sharp Decay] $m \geq 0, N = 2n$ or $2n + 1$

$$(u_0, u_1) \in (H^{m+1}(\mathbb{R}^N) \cap W^{n,1}(\mathbb{R}^N)) \times (H^m(\mathbb{R}^N) \cap W^{n-1,1}(\mathbb{R}^N))$$

$$\Rightarrow \|\partial_t^k \nabla_x u(t)\|_{L^q(\mathbb{R}^N)} \leq C(1+t)^{-k - \frac{|\beta|}{2} - \frac{N}{2}(1 - \frac{1}{q})}$$

$$(1 \leq q \leq 2, 0 \leq k + |\beta| \leq m, k \neq m)$$

2. Nonlinear Degenerate Dissipative Kirchhoff Equation:

$$\begin{cases} \rho \partial_t^2 u - (\int_{\Omega} |\nabla_x u(x, t)|^2 dx)^\gamma \Delta_x u + \partial_t u = 0 & \text{in } \Omega \times (0, \infty) \\ (u, \partial_t u)|_{t=0} = (u_0, u_1) & \text{in } \Omega, \quad \Omega : \text{bounded in } \mathbb{R}^N \\ u(x, t) = 0 & \text{on } \partial\Omega \times (0, \infty) \end{cases}$$

[Optimal Decay] $\rho > 0, \gamma > 0$

$$(u_0, u_1) \in (H^2(\Omega) \cap H_0^1(\Omega)) \times H_0^1(\Omega), u_0 \neq 0, \rho \ll 1$$

$$\Rightarrow C^{-1}(1+t)^{-\frac{1}{\gamma}} \leq \|\nabla_x^k u(t)\|_{L^2(\Omega)}^2 \leq C(1+t)^{-\frac{1}{\gamma}} \quad (k = 0, 1, 2)$$

3. Vlasov-Poisson-Fokker-Plank System:

$$\begin{cases} \partial_t f + v \cdot \nabla_x f + E \cdot \nabla_v f - \Delta_v f = 0 & \text{in } \mathbb{R}^N \times \mathbb{R}^N \times (0, \infty) \\ -\Delta_x U = \gamma \int_{\mathbb{R}^N} f(x, v, t) dv, \quad E = -\nabla_x U \\ f(x, v, 0) = f_0(x, v) & \text{in } \mathbb{R}^N \times \mathbb{R}^N, \quad \gamma = \pm 1 \end{cases}$$

[Asymptotic Behavior] $1 \leq p \leq \infty$

$$f_0 \in L^p(\mathbb{R}^N \times \mathbb{R}^N), \|f_0\| \ll 1$$

$$\Rightarrow \|\nabla_x^\alpha \nabla_v^\beta f(t) - \nabla_x^\alpha \nabla_v^\beta h(t)\|_{L^q(\mathbb{R}^N \times \mathbb{R}^N)} \leq C t^{-\frac{1}{2}(3|\alpha| + |\beta|)} (1+t)^{-\frac{1}{2} - 2N(1 - \frac{1}{q})} \quad (1 \leq q \leq p)$$

where h is the solution of the linear Fokker-Plank system

Content:

By using the functional analysis approach, I study on the structure of solutions and the decay estimate of energy for nonlinear PDEs that describe the nonlinear phenomena. In a study of nonlinear equations, detailed analysis of the corresponding linear equation becomes essential. I examine the relationship of the nonlinearity of the equations and the functional spaces to which the solutions belong, and I investigate on global solvability in time of solutions or blow-up problems for PDEs. In addition, I research on decay estimates the energy function and the derivatives.

Nonlinear degenerate dissipative Kirchhoff equations are nonlinear PDEs that describe the nonlinear wave phenomena. Solutions of these equations have decay estimates of the same polynomial order from above and blow.

Vlasov-Poisson systems are basic equations that describe plasma phenomena, in particular, the solution of the Vlasov-Poisson-Fokker-Plank system is asymptotic to the solution of the corresponding linear Fokker-Plank system.

Keywords : Nonlinear Analysis, PDEs

Field : Mathematical Sciences

E-mail : k.ono@tokushima-u.ac.jp

Tel. +81-88-656-7218

Fax : +81-88-656-7218

HP : <http://www-math.ias.tokushima-u.ac.jp/>



Faculty of
Science and
Technology
Tokushima University

Applications of Number Theory and Algebraic Systems

Professor Hiroki Takahashi

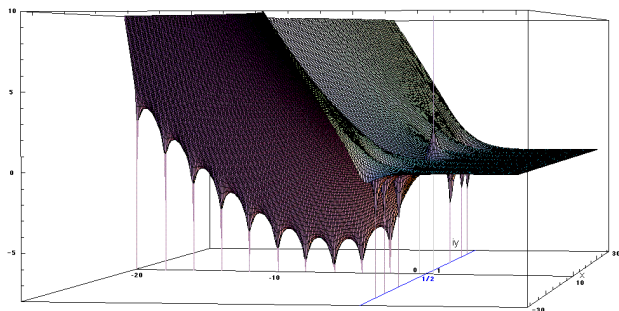

Fig.1 $\log|\zeta(s)|$ ($\zeta(s)$: Riemann zeta function)

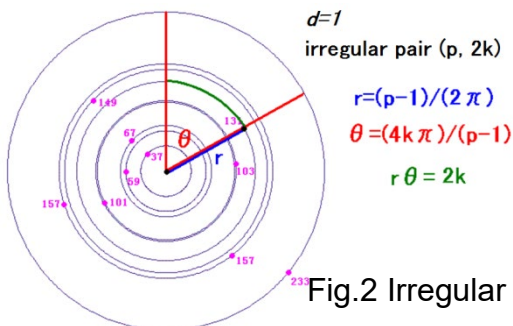

Fig.2 Irregular primes and indices

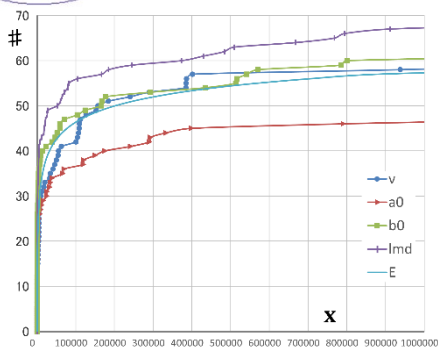

Fig.3 The number of exceptional primes

Content:

The main subject of our research is the ideal class groups of algebraic number fields. We have particularly investigated Greenberg's conjecture and Vandiver's conjecture on the class numbers of real cyclotomic fields by using computers. Furthermore, we are also interested in new applications of algebraic systems such as algebraic number fields and elliptic curves, which have strong connections with cryptography.

A lot of mathematicians have been interested in Riemann zeta function (cf. Fig.1). Its special values have deep relations with the ideal class groups of cyclotomic fields (cf. Fig.2). These relations are expressed as correspondences of the class numbers of real cyclotomic fields and the indices of their circular units in full ones.

Greenberg's conjecture states that their p -parts are bounded in the \mathbb{Z}_p -extension. Moreover, Vandiver's conjecture states that they are trivial for p -cyclotomic fields. We have been studied these conjectures by using arithmetic special elements such as cyclotomic units, Gauss sums, p -adic L-functions and auxiliary prime numbers. As results, we could find a lot of examples for which Greenberg's conjecture holds, and a lot of exceptional prime numbers for the Iwasawa invariants (cf. Fig.3).

Keywords : algebraic number field,
class number, elliptic curve, cryptography
E-mail: hirokit@tokushima-u.ac.jp
Tel. +81-88-656-7549
Fax: +81-88-656-7549
HP : <https://math0.pm.tokushima-u.ac.jp/~hiroki/index.html>





Numerical Computation for Population Pharmacokinetics

Professor Toshiki Takeuchi

$$S = 2l \sum_{j=1}^n \log \alpha(t_j; x) + \sum_{j=1}^n \frac{(c_j - \alpha(t_j; x))^2}{f \alpha(t_j; x)^2} + \sum_{i=1}^n \frac{(x_i - 1)^2}{i^2}$$

(a) Objective function in nonlinear optimization problem

$C(t) = \alpha(t; V_d, V_{max}, K_m)$: Concentration

$$\frac{dX_a(t)}{dt} = -k_a X_a(t)$$

$$\frac{dC(t)}{dt} = \frac{F k_a X_a}{V_d} - i \frac{V_{max} C}{V_d(K_m + C)} \quad t_i \leq t < t_{i+1} \quad (i = 1; 2; \dots)$$

$$X_a(t_i) = \begin{cases} D_i & i = 1 \\ D_i + \lim_{t \rightarrow t_i^0} X_a(t) & i = 2 \end{cases} \quad C(t_i) = \begin{cases} 0 & i = 1 \\ \lim_{t \rightarrow t_i^0} C(t) & i = 2 \end{cases}$$

(b) Differential equations (phenytoin)

Fig. 1 Bayesian estimation for pharmacokinetics

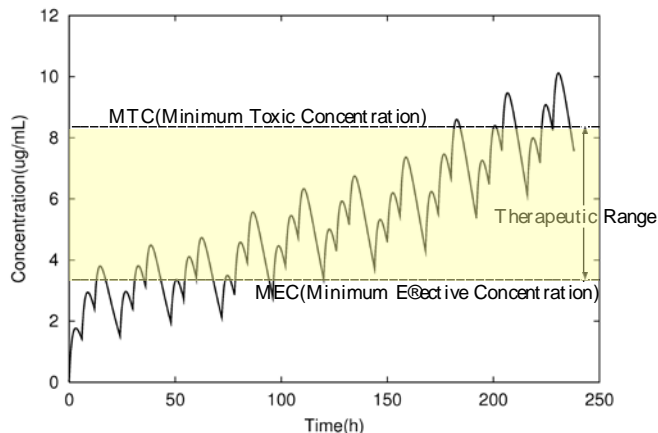

Fig. 2 Profile of the concentration and the therapeutic range

Content:

Pharmacokinetics plays an important role in efficacy and safety pharmacotherapy. The estimation of individual pharmacokinetic parameters from a few concentration data is desirable in quick therapy. Bayesian estimation using the population pharmacokinetic parameters is useful for the estimation of individual pharmacokinetic parameters. Here, population pharmacokinetic parameters mean statistic including average, variance and correlation coefficient. The numerical calculation of nonlinear optimization is essential to Bayesian estimation or computation for population pharmacokinetic parameters. In addition, the theoretical value of concentration data may be given with a nonlinear differential equation. The stable computation in nonlinear optimization for pharmacokinetics is difficult because of the strong nonlinearity. I am developing a stable and high-precision numerical method for nonlinear optimization problem in population pharmacokinetics and Bayesian estimation.

Keywords: Numerical analysis, Nonlinear optimization

E-mail: takeuchi@tokushima-u.ac.jp

Tel. +81-88-656-7544

Fax: +81-88-656-7544



Faculty of
Science and
Technology
Tokushima University

Constructions of graphs with self-similar structures and their structural properties with applications

Professor Toru Hasunuma

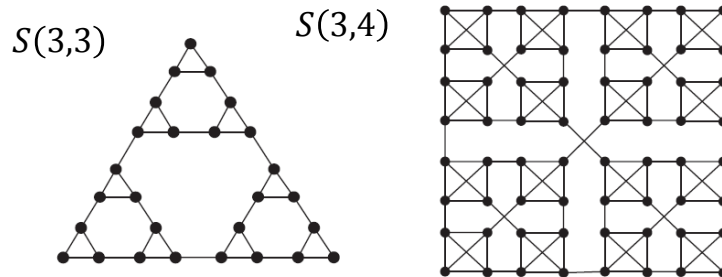

Fig.1 : Sierpiński graphs.

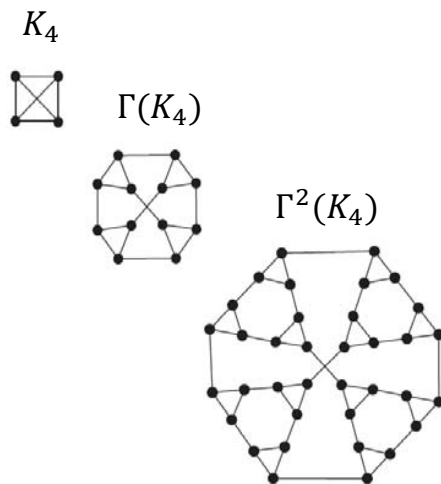

Fig. 2: Applications of the subdivided-line graph operation to the complete graph K_4 .

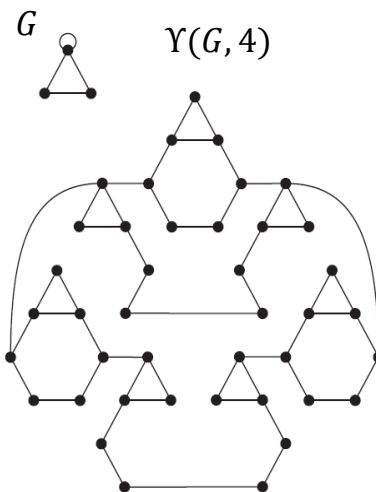

Fig. 3: Universalized Sierpiński graphs.

Content:

Sierpinski graphs $S(n, k), n \geq 1, k \geq 2$ are known to be graphs with self-similar structures and their various properties have been studied until now. It is also known that Sierpinski graphs are isomorphic to WK-recursive networks which have been proposed as interconnection networks for massively parallel computers because of their remarkable extendability. The purpose of this study is mainly to investigate their structural properties with applications to interconnection networks.

In this study, we newly introduced the subdivided-line graph operation Γ and showed that $S(n, k)$ is obtained from $S(n - 1, k)$ by applying Γ . Although $S(n, k)$ can be obtained by combining k copies of $S(n - 1, k)$ based on the definition, the constructions by Γ help us to investigate structural properties of $S(n, k)$ directly from those of $S(n - 1, k)$. So far, we have obtained results on structural properties of subdivided-line graphs concerning interconnection networks such as diameter, connectivity, edge-disjoint Hamiltonian cycles, several variants of dominating sets, completely independent spanning trees, and book-embeddings. Besides, we newly defined the class of universalized Sierpinski graphs apart from the class of subdivided-line graphs, and have been investigating their structural properties.

Keywords : subdivided-line graphs, universalized Sierpinski graphs

E-mail: hasunuma@tokushima-u.ac.jp

Tel. +81-88-656-7216

Fax: +81-88-656-7216



Limit Cycles for 3D Competitive Lotka-Volterra systems

Professor Kouichi Murakami

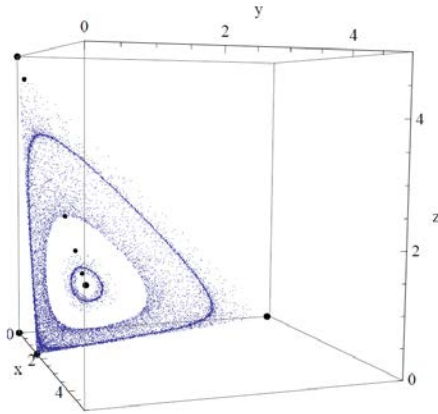

Fig.1 Phase Portrait of Zeeman's class 27

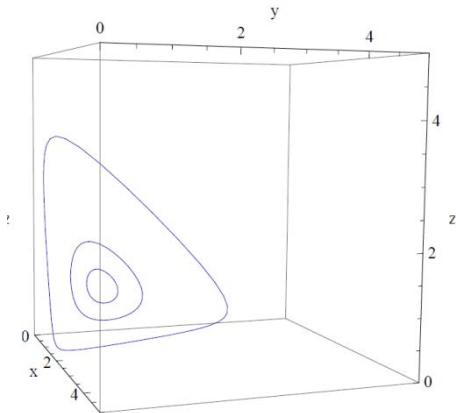

Fig.2 Limit cycles of Zeeman's class 27

Content:

2D Lotka-Volterra equations cannot have limit cycles. That is, except for conservative systems, the limit set consists of equilibria only. On the other hand, 3D Lotka-Volterra systems allow various types of complicated dynamics.

As long as we restrict 3D competitive Lotka-Volterra systems, the possibility of the dynamics is limited. Hirsch showed that competitive systems have the order preserving property, and there is an invariant manifold (called the carrying simplex) which attracts all orbits except for the origin. Thus, in 3D competitive systems, the Poincaré-Bendixson theorem holds, and therefore the limit set consists of equilibria, limit cycles and heteroclinic orbit only. Zeeman has divided all possible phase portraits of 3D competitive Lotka-Volterra systems into 33 classes and showed that six classes can have the Hopf bifurcation. Hofbauer and So constructed an example with two limit cycles in Zeeman's class 27.

In this study, we present a concrete example with multiple limit cycles for 3D competitive Lotka-Volterra systems. For instance, we obtain an example with three limit cycles in Zeeman's class 27 as shown in figures.

Keywords: differential equations, Hopf bifurcation, limit cycles

E-mail: murakami@ias.tokushima-u.ac.jp

Tel. +81-88-656-7221

Fax: +81-88-656-7221



Differential structure and topological properties

Professor Kazumine Moriyasu

<図表>

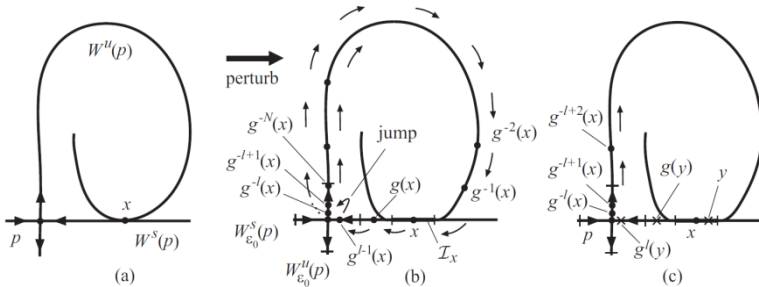
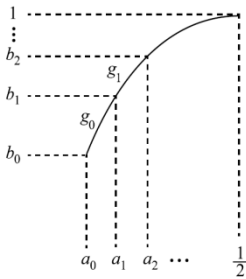
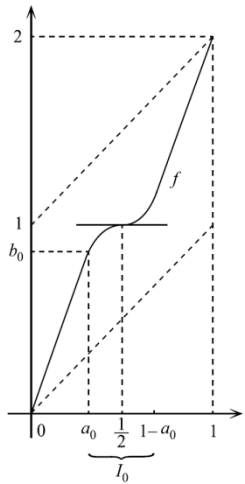
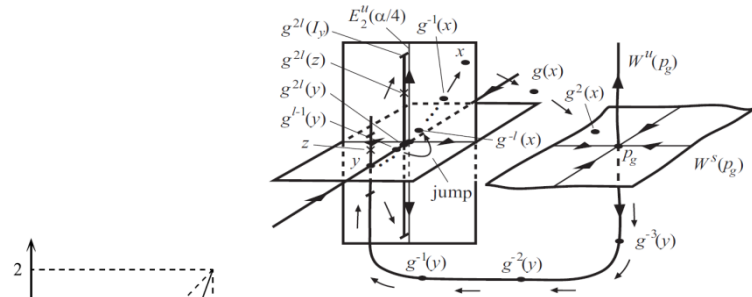

Content:

The relation between differential structure and topologic properties that the maps on the closed manifold has are studied for a long time, and there is much result. For example, the relationship between uniformly hyperbolic properties and expansive properties and shadowing properties, non-uniformly hyperbolic properties is a hyperbolic of partially hyperbolic and dominated splitting and the phase shift of the relationship. Recently, a new concept that the topological nature was recaptured from the measure theory point of view, such as expansion of and follow-up property can be considered, it has been investigated the relationship between the set with a uniform hyperbolicity. Although research the current has remained on the relationship between the uniformly hyperbolic properties are expected to lead the relationship between non-uniformly hyperbolic properties by adding the viewpoint of measure theory.

In this study, it is intended that I check the relations with these properties for the meeting having non-uniformly hyperbolic properties in addition to the uniformly hyperbolic properties. Particularly, I think that I can find the connection of a gauging theory-like property and a topologic property by clarifying the topologic property that the one Pesin set of the meeting having non-uniformly hyperbolic properties has.

Keywords : hyperbolic structure, stability, Pesin set

E-mail: moriyasu@tokushima-u.ac.jp

Tel. +81-88-656-7220

Fax: +81-88-656-7220



Mathematical Optimization with Randomness and Fuzziness

Associate Professor Takeshi Uno

Fuzzy random variable

Example: sales of an amusement park

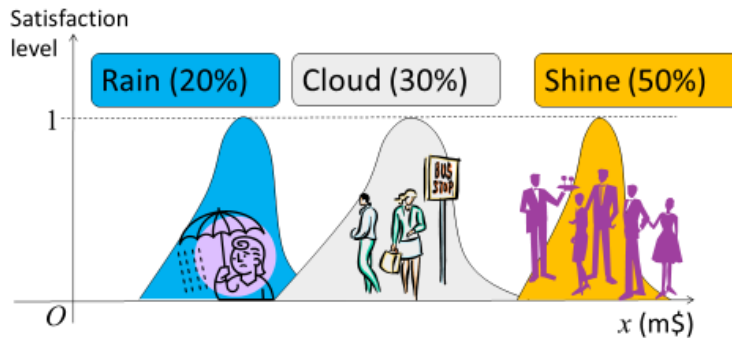

Particle Swarm Optimization (PSO)

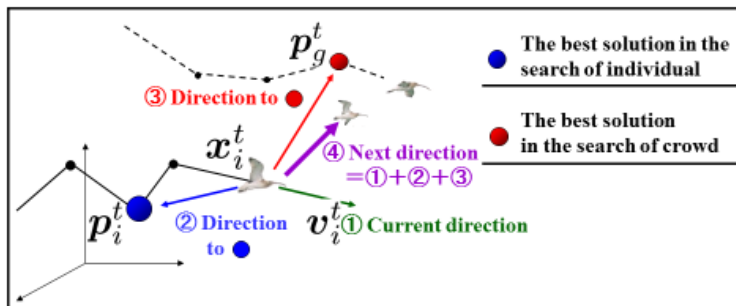

$$v_i^{t+1} = \omega v_i^t + c_1 R_1^t (p_i^t - x_i^t) + c_2 R_2^t (p_g^t - x_i^t)$$

$$x_i^{t+1} = x_i^t + v_i^{t+1}$$

Content:

Mathematical optimization is defined as finding the best solution for mathematical problems formulating real world problems, e.g. production planning, location, etc.

An important issue for applying mathematical optimization is “uncertainty”, which can be divided into the following two types: one is “randomness”, which is included in random factors, e.g. weather, economic conditions, etc. The other is “fuzziness”, which is included in evaluation or judgment of human beings. Because real world problems include both randomness and fuzziness, I study modeling for mathematical optimization by applying “fuzzy random variables”, representing them simultaneously.

Formulated mathematical problems often have enormous decision variables and conditions with complex characteristics. Because of the difficulty of solving them strictly, we study evolutionary computing, e.g. GA and PSO, for finding their good solutions efficiently.

Keywords: Operations Research (OR),
Soft Computing

E-mail: uno.takeshi@tokushima-u.ac.jp

Tel. +81-88-656-7294

Fax: +81-88-656-7294

HP : <http://www-math.ias.tokushima-u.ac.jp/~uno/>





A comparison principle and a strong comparison principle of nonlinear partial differential equations

Associate Professor Masaki Ohnuma

Let $\Omega \subset \mathbf{R}^N$ (domain). We consider the following PDE.

$$(1.1) \quad F(x, Du(x), D^2u(x)) = 0 \quad \text{in } \Omega,$$

$$Du = \left(\frac{\partial u}{\partial x_1}, \dots, \frac{\partial u}{\partial x_N} \right), \quad D^2u = \left(\frac{\partial^2 u}{\partial x_i \partial x_j} \right) \quad (\text{Hessian of } u).$$

$D^2u \in \mathbf{S}^N$ ($N \times N$ real symmetric matrices)

Example of (1.1) (**the minimal surface equation for graph.**)

$$(1.2) \quad -\sqrt{1 + |Du|^2} \operatorname{div} \left(\frac{Du}{\sqrt{1 + |Du|^2}} \right) = 0 \quad \text{in } \Omega.$$

Example of (1.1) (**the prescribed mean curvature equation.**)

For a given function $H \in C^1(\Omega)$,

$$(1.3) \quad \operatorname{div} \left(\frac{Du}{\sqrt{1 + |Du|^2}} \right) = NH \quad \text{in } \Omega.$$

Content:

I am interested in the study of a comparison principle and a strong comparison principle for semicontinuous solutions of nonlinear partial differential equations.

As partial differential equations I considered the minimal surface equation, the prescribed mean curvature equation, the level set equation of the mean curvature flow equation, the level set equation of an anisotropic curvature equation and p-Laplace diffusion equation. As well known the above equations are degenerate and singular. Usually for such equation, we cannot expect existence of classical solutions. So I will consider such equations with viscosity solutions.

For elliptic equations:

Comparison principle: Let u be a lower semicontinuous supersolution, and let v be an upper semicontinuous subsolution. On the boundary of the domain we considered if u is greater than or equal to v , then it holds in the whole domain.

Strong comparison principle: Assume in the whole domain u is greater than or equal to v . If u touches v in an interior point of the domain, then u is equivalent to v in the whole domain.

Keywords: partial differential equation, viscosity solution

E-mail: ohnuma@tokushima-u.ac.jp

Tel. +81-88-656-7225

Fax: +81-88-656-7225

Comparison Principle (elliptic)

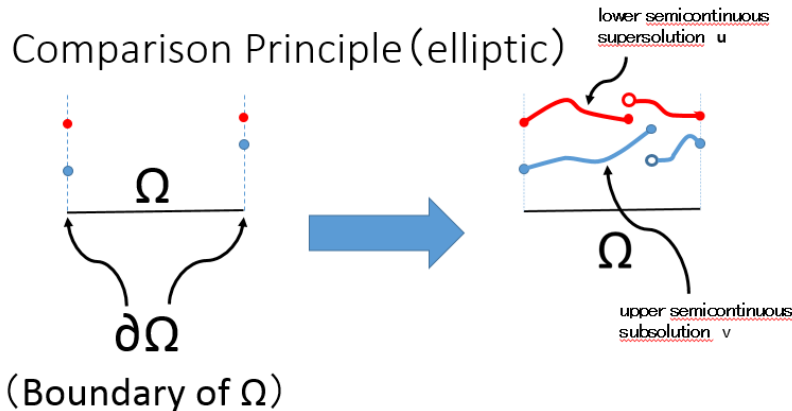



Embedded Topology of Plane Curves

Associate Professor Taketo Shirane

<図表>

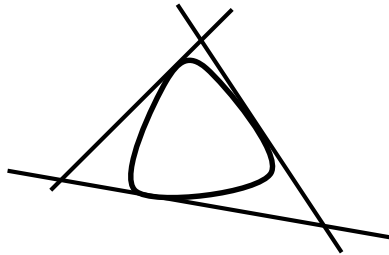

A plane curve consisting of
a smooth curve and three lines

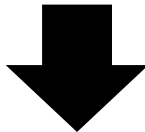

The pull-back of three
lines under a Galois
cover branched along
the smooth curve

Case 1.
Several triangles

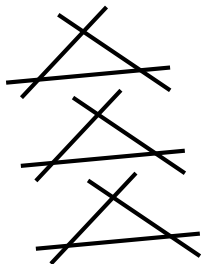

Case 2.
One polygon

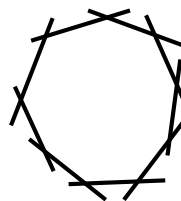

This difference show difference of embedded
topology of plane curves.

Content:

It is known that two algebraic curves on the complex projective plane (called plane curves) may have different embedded topology if arrangement of their singularities are different. Namely, one plane curve cannot be deformed continuously to the other curve in the projective plane. I study the criterion for distinguishing the embedded topology of plane curves.

The complex dimension of complex projective plane is 2. Hence the real dimension of the plane is 4. The difficulty of this study is that we do not know how to watch the whole of the plane. Thus we need a language to represent difference of embedded topology of plane curves.

Recently, it is known that the “splitting” of plane curves by pull-back under a Galois cover over the plane represent difference of embedded topology of plane curves. In this study, we define the invariant “splitting graph” which is a language for representing the splitting of plane curves for Galois covers, and give a criterion for distinguishing embedded topology of plane curves.

Keywords: Plane Curve,
Embedded Topology,
Galois Cover

E-mail: Shirane@tokushima-u.ac.jp

Tel. +81-88-656-7295

Fax: +81-88-656-7295



Time-Complexity

Polynomial Time

$$O(\log n) \quad O(n)$$

$$O(n^2) \quad O(n^k)$$



Exponential Time

$$O(2^n) \quad O(2^{2n})$$

$$O(2^{n^2})$$

(n is the size of input data and k is the constant number.)

The most fundamental classification is the distinction between problems whose growth rate in terms of time is polynomial and problems whose growth rate is exponential.

$P \neq NP$ Problem

NP

The class *NP* is the set of decision problems whose solutions can be determined by a non-deterministic Turing machine in polynomial time.

P

The class *P* consists of all problems that can be efficiently computed.

The $P \neq NP$ problem is whether *P* and *NP* are in fact the same.

Content:

Computational complexity theory is a branch of the theory of computation in theoretical computer science that focuses on classifying computational problems according to their inherent difficulty, and relating those classes to each other. One aspect of computational complexity is related to an *algorithm* for solving instances of a *problem*. The computational complexity of an algorithm is a measure of how many steps the algorithm will require in the worst case for an instance or input of a given size. The number of steps is measured as a function of that size. Moreover, the theory of computational complexity involves classifying problems according to their inherent tractability or intractability, that is, whether they are “easy” or “hard” to solve. This classification scheme includes the well-known classes *P* and *NP*; the terms “*NP*-complete” and “*NP*-hard” are related to the class *NP*.

In our research, given a problem, we clarify which class it is belong to, and develop an efficient algorithm for solving it if it is belong to the class *P*.

Keywords : computational complexity, algorithm

E-mail: shin@tokushima-u.ac.jp

Tel. +81-88-656-7223

Fax: +81-88-656-7223



Faculty of
Science and
Technology
Tokushima University

Arithmetic Geometry, Arithmetic Differential Equations

Associate Professor Kazuaki Miyatani

<図表>

Theory of complex differential
equations
e.g. hypergeometric functions



p-adic differential
equations



Arithmetic theory
e.g. hypergeometric functions over
finite fields

Content:

My research field is arithmetic geometry. This is a field that investigates arithmetic properties based on ideas from various areas of mathematics, primarily complex geometry and complex analysis.

I am particularly interested in p-adic differential equations. The key ingredient is the world of "p-adic numbers", which serves as a bridge between the world of "characteristic 0" (i.e. adding 1 repeatedly never results in 0) and the world of "characteristic p" (i.e. adding p copies of 1 results in 0, where p is a prime number). Functions and differential equations in p-adic numbers sometimes show an interesting feature: while they look like objects in the complex number world, they also possess number-theoretic information.

I have studied general (single-variable, with an arbitrary number of parameters) hypergeometric differential equation in p-adic numbers. Then, I proved that this equation has an information of an algebraic-number-theoretic function which is called "hypergeometric functions over finite fields".

Currently, I am studying various objects on p-adic numbers, somehow related to hypergeometric functions, to investigate other interesting connections between complex number world and p-adic number world.

Keywords : Arithmetic geometry

E-mail: miyatani@tokushima-u.ac.jp

Tel. +81-88-656-7546

Fax:

HP : <https://math.miyatani.org/>



Faculty of
Science and
Technology
Tokushima University

Solvability of Hyperbolic Systems of Conservation Laws

lecturer Kuniya Okamoto

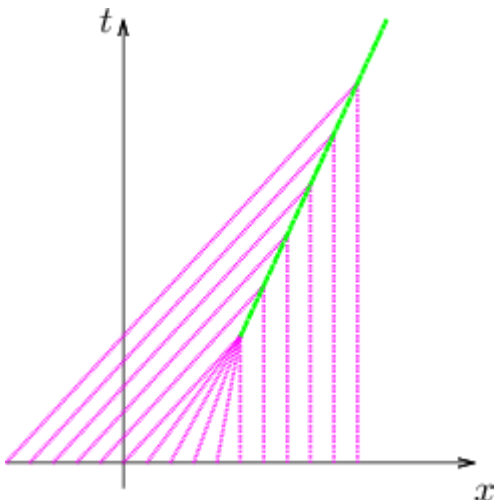
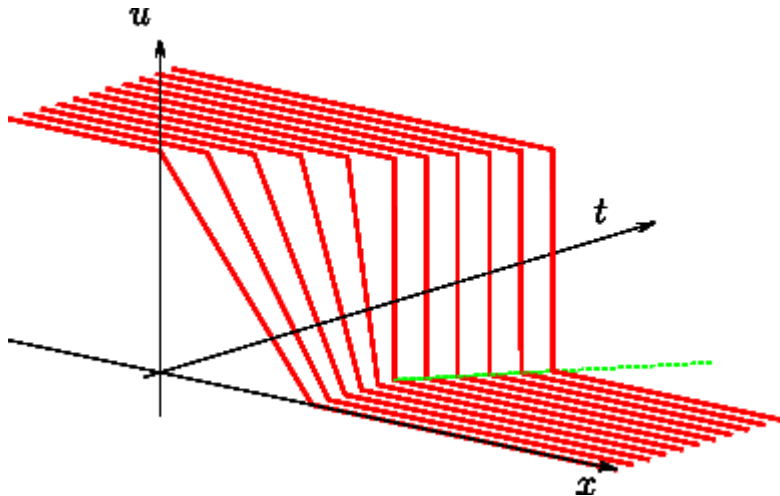

Content:

Hyperbolic systems of conservation laws described as the first order quasilinear partial differential equations have been extensively studied. The most remarkable feature is that not only this type of equations do not possess the smoothing effects but also the regularities of classical solutions will be lost in finite time even if the initial data are smooth. We introduce the notion of weak solutions which interprets the derivatives of solutions in the generalized sense, then we need to allow the presence of discontinuities in the solutions such as shock waves and discuss the solvability in the wider class. However, in contrast to the single conservation laws, the case of systems has not yet been successfully solved until recently, except for the case that the total variation of initial data is sufficiently close to the equilibrium. In terms of the interaction potential estimates of Glimm type, we study the approximate solvability of a system of conservation laws and the stability of weak solutions even if the total variations of initial data are not small for the presence of large oscillations.

Keywords : Hyperbolic systems, Conservation laws

E-mail: okamoto-kuniya@tokushima-u.ac.jp

Tel. +81-88-656-9441

Fax: +81-88-656-9441

HP :



Liouville theorem with growth condition

$$u : \mathbb{R}^m \rightarrow \mathbb{S}_+^n \quad \text{Harmonic Map}$$

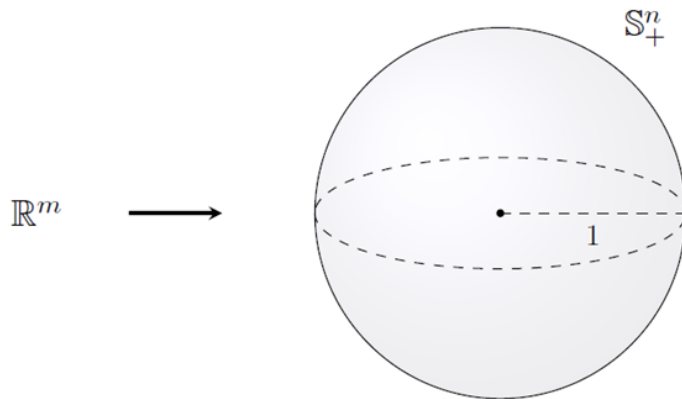

Growth Condition

$$\frac{1}{\cos \rho(u(x))} = o(d(x)), \quad d(x) \rightarrow +\infty$$



Non-trivial harmonic map does not exist

Content:

Nonexistence of harmonic maps

Harmonic maps are critical points of the energy functional. A Liouville type theorem states non-existence of harmonic maps. We showed that a Liouville type result holds under some optimal growth condition.

Instability of minimal submanifolds

Minimal submanifolds are critical points of the volume functional. The instability of minimal submanifolds are measured by Morse index. We are trying to derive an appropriate index estimate via the Betti numbers, which are topological information of minimal submanifolds.

Heat equation along geometric flows

We are interested in time-dependent Riemannian manifolds like Ricci flow. In particular, we study the behavior of heat equations under such time-dependent situations.

Keywords: Geometric Analysis

E-mail: kunikawa@tokushima-u.ac.jp

Tel. +81-88-656-7228

Fax:

HP: <https://k-kunikawa.github.io/>





Analysis of the stationary Navier-Stokes equations

Lecturer Hiroyuki Tsurumi

Stationary Navier-Stokes equations:

$$\begin{cases} -\Delta \mathbf{u} + (\mathbf{u} \cdot \nabla) \mathbf{u} + \nabla p = \mathbf{f} \\ \operatorname{div} \mathbf{u} = 0 \end{cases} \quad (\text{E})$$

\mathbf{u} : flow velocity, p : pressure \leftarrow unknown

\mathbf{f} : external force \leftarrow given

Image: Function spaces of \mathbf{f}

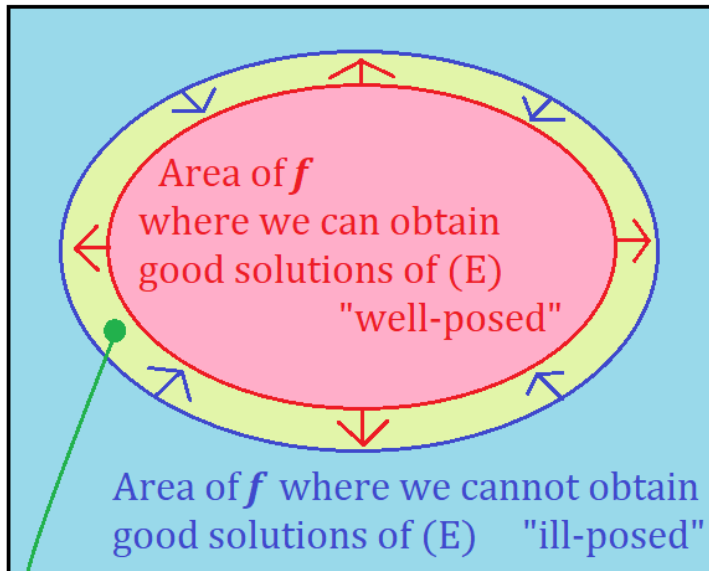

Where is the border line ?

Content:

I am interested in the stationary Navier-Stokes equations, which describes the behavior of a fluid with no time variation of flow velocity. The purpose is to find the borderline between the well-posedness (existence, uniqueness, and continuous dependence of solutions for given external forces) and ill-posedness in terms of function spaces for solutions and external forces.

In the case of the two-dimensional whole space, the analysis of this equation is extremely difficult (due to a phenomenon known as Stokes' paradox). However, there is a few previous studies on the well-posedness around special solutions (e.g., uniform, symmetric, and rotational flows) and the ill-posedness around a trivial solution (zero). Based on these studies, I aim to generalize the conditions for both well-posedness and ill-posedness, and to construct a systematic analysis method for the two-dimensional case.

Keywords : fluid dynamics, partial differential equations, functional analysis

E-mail: tsurumi.hiroyuki@tokushima-u.ac.jp

Tel. +81-88-656-7542

Fax: +81-88-656-7542



Derived Categories of Commutative Rings

Lecturer Hiroki Matsui

<図表>

Tensor Triangular Geometry : Balmer (2005)

$$X \cong \text{Spec}_{\otimes}(\text{D}^{\text{pf}}(X))$$



Forgetting the tensor structure

Triangular Geometry : Matsui (2021)

$$X \subseteq \text{Spec}_{\Delta}(\text{D}^{\text{pf}}(X))$$

The left-hand sides contain geometric information on original Noetherian scheme X and the right-hand sides contain (tensor) triangulated category structure. Hence the above results connect them.

Content:

One of the most classical and important problems in commutative algebra is to classify all modules up to isomorphisms. This problem is quite difficult and it is known to be hopeless in general.

On the other hand, classifying subcategories (certain classes of objects) of a given category is a more manageable approach than classifying objects. So far, there are many results in this approach.

My research aims to connect geometric information on a given commutative ring R or more generally a scheme X and triangulated category structure of their derived categories using classifications of subcategories. In 2005, Balmer developed "tensor triangular geometry" and proved that the tensor triangulated category structure of the perfect derived category $\text{D}^{\text{pf}}(X)$ determines the original Noetherian scheme X . However, tensor structures are too strong in general and there are various important examples of triangulated categories without natural tensor structures.

Recently, I have generalized his theory without using tensor structure. As Balmer's theory is, this theory is expected to apply in many areas in mathematics such as algebraic geometry, representation theory of groups, stable homotopy theory, and so on.

Keywords: Commutative ring/Scheme,
Derived Categories

E-mail: hmatsui@tokushima-u.ac.jp

Tel. +81-88-656-7296

Fax: +81-88-656-7296



Differential geometry of smooth and discrete surfaces

Lecturer Masashi Yasumoto

<図表>

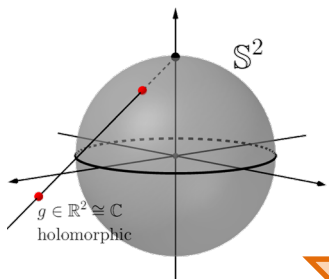

Inverse image of stereo. proj.
 $\mathbb{C} \ni g$
 $\mapsto \left(\frac{2\text{Re}(g)}{1+|g|^2}, \frac{2\text{Im}(g)}{1+|g|^2}, \frac{-1+|g|^2}{1+|g|^2} \right)$

Lift it to 4-dimensional
Minkowski space

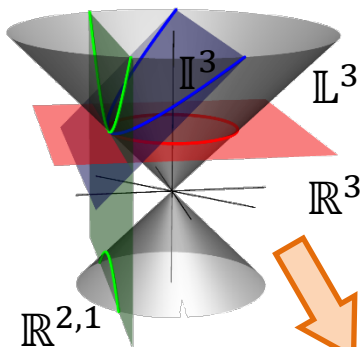

We can describe spaces
in a unified way, including
the Euclidean space.

Applying a transformation...

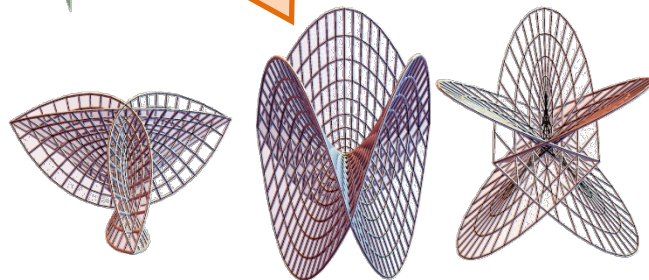

We can construct various
smooth and discrete surfaces.

Content:

Differential geometry of surfaces is an important research field with a long history that forms the basis of modern differential geometry. Recently, with the development of computer science and related fields, it has been actively studied to reorganize and reconstruct conventional differential geometry in a discrete setting.

I am working on the differential geometry of surfaces and discrete surfaces. In the study of differential geometry, there is a concept of curvatures that describe how curved geometric objects such as curves and surfaces are. The study of differential geometry with specific curvature conditions is interesting because it intersects with various mathematical studies.

In our recent work, we derived constructions of various discrete surfaces by developing discrete surface theory in 4-dimensional Minkowski space. This includes discrete minimal surfaces in 3-dimensional Euclidean space. This result not only unifies the conventional constructions of discrete surfaces, but also leads to the construction of new discrete surfaces.

Keywords: discrete differential geometry,
integrable systems

E-mail: yasumoto.masashi@tokushima-u.ac.jp

Tel. +81-88-656-7297

Fax:

HP : [https://sites.google.com/site/](https://sites.google.com/site/homepageofmasashiyasumoto/home)

[homepageofmasashiyasumoto/home](https://sites.google.com/site/homepageofmasashiyasumoto/home)