



Faculty of
Science and
Technology
Tokushima University

Development of Diagnostic Techniques for Power Equipment Using Radio Remote Sensing and Signal Processing

Professor Masatake Kawada

Development of Insulation Diagnostic Techniques for Distribution Line Using FDTD Method

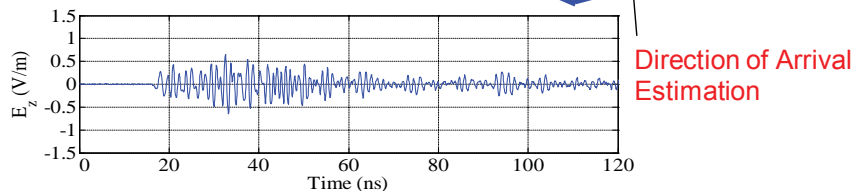
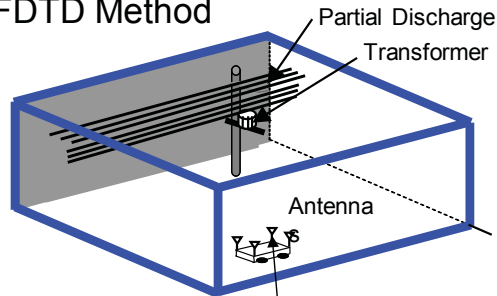

Electromagnetic Waves Emitted from a Partial Discharge Source,
which is a Symptom of Deterioration of Insulating Materials.

Detection of Abnormal Vibration Using Wavelet Transform

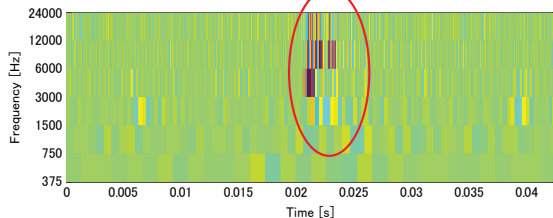
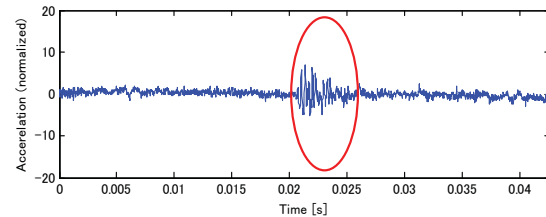
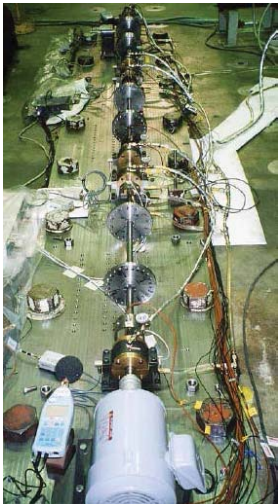

Time-Frequency Visualization of Abnormal
Vibration

Content:

1. Subject

Can faults due to deterioration over time or unexpected faults occurring in power equipment be detected beforehand?

2. Research Contents

How to detect a symptom of faults ?

(1) Radio Sensing, to locate the positions of deterioration of insulating materials

(2) Signal Processing, to locate abnormal positions in turbines, generators, and pumps

3. Record of Joint Research

(1) Chubu Electric Power Co. Inc. and Mitsubishi Heavy Industries Ltd. for diagnosing turbine generators

(2) Chubu Electric Power Co. Inc. and Hitachi Ltd. for diagnosing pumps

(3) Railway Technical Research Institute for diagnosing ground coils of superconducting Maglev

Keywords : Radio Sensing and Signal Processing

E-mail: kawada@ee.tokushima-u.ac.jp

Tel. +81-88-656-7460

Fax: +81-88-656-7460

HP: <http://pub2.db.tokushima-u.ac.jp/ERD/>

[person/25080/profile-ja.html](http://pub2.db.tokushima-u.ac.jp/ERD/person/25080/profile-ja.html)





Faculty of
Science and
Technology
Tokushima University

Inverse LQ Regulator of Systems with Time Delay

Professor Tomohiro Kubo

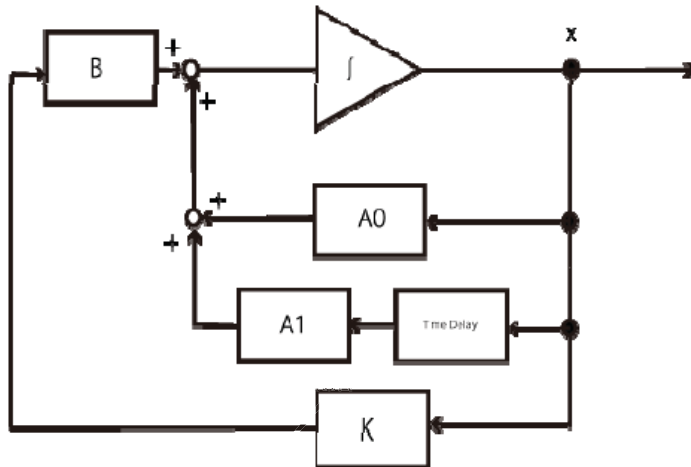

Fig.1 Feedback control of a time delay system

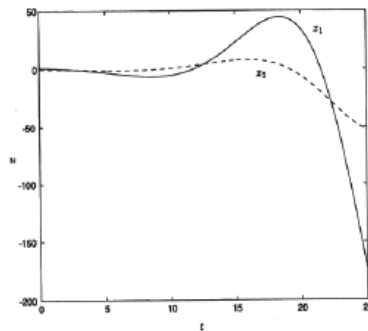

Fig.2 Open loop system

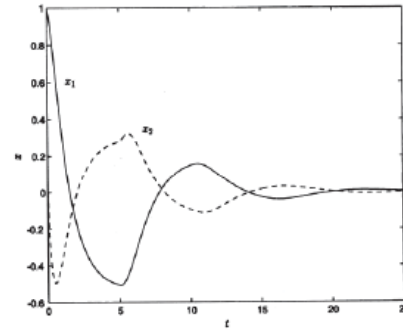

Fig.3 Closed loop system

Content:

Systems with time delay belong to a class of infinite dimensional systems. To construct a linear quadratic regulator of such a system, generally a solution of an infinite dimensional Riccati equation is required to calculate the feedback gain and a real-time integral operation is included in the feedback law.

To stabilize such systems, we propose a method to construct an inverse linear quadratic regulator. The feedback gain can be calculated from a solution of a finite dimensional Riccati equation or a finite dimensional linear matrix inequality, and the feedback law is so-called the memoryless feedback which doesn't include a real-time integral operation as shown in Fig. 1. The resulting closed loop system can be shown to be stable (compare Fig. 2 and Fig. 3 for example), and to be a linear quadratic regulator for some quadratic cost functional. Moreover, it is assured to have a good robustness property against a class of static nonlinear perturbations or dynamic linear perturbations in the input channel as well as a linear quadratic regulator for systems without time delay.

Keywords : time delay, LQ regulator, robust stability

E-mail: kubo@ee.tokushima-u.ac.jp

Tel. +81-88-656-7466

Fax: +81-88-656-7466





Faculty of
Science and
Technology
Tokushima University

Heuristic Algorithm for Optimization Problems

Professor Takashi Shimamoto

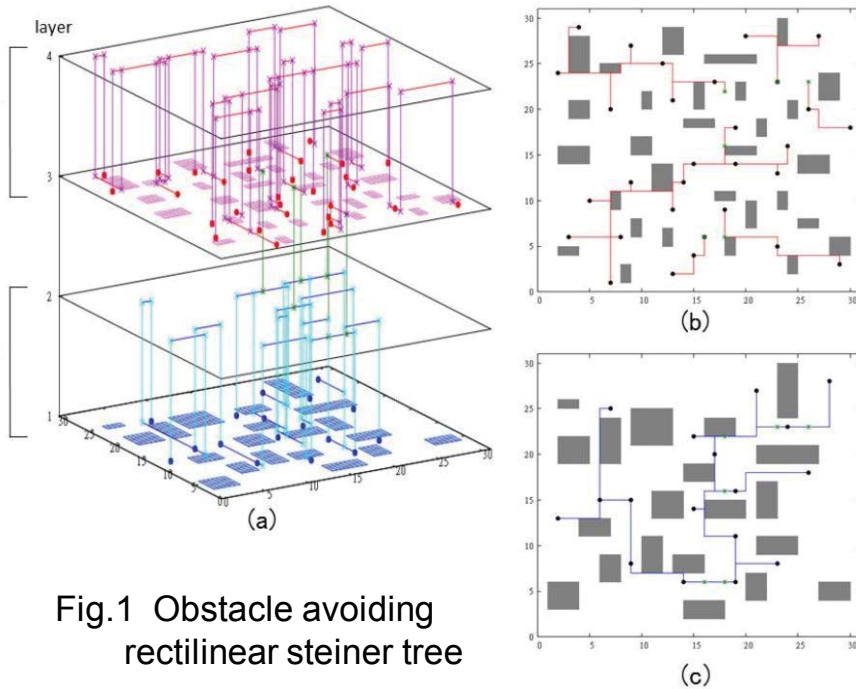

Fig.1 Obstacle avoiding
rectilinear steiner tree

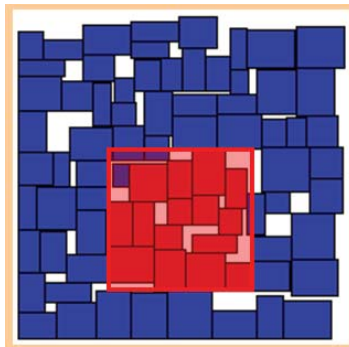

Fig.2 Voltage assignment in floorplan

Content:

Research of heuristic algorithm
for optimization problems in LSI layout design

For example,

- Obstacle avoiding rectilinear steiner tree (Fig.1)
- Voltage assignment in floorplan (Fig.2)
- 3D-IC floorplanning with TSV co-placement

Keywords : Heuristic Algorithm, Optimization Problem,
LSI Design

E-mail: simamoto@ee.tokushima-u.ac.jp

Tel. +81-88-656-7483

Fax: +81-88-656-7471





Faculty of
Science and
Technology
Tokushima University

Pulsed Power Application on Environment Engineering and Bioengineering

Professor Naoyuki Shimomura

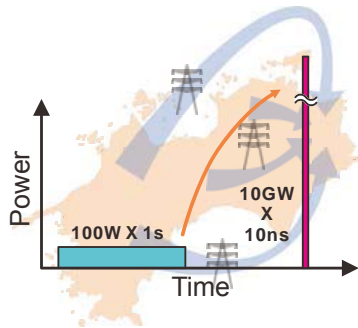

Fig.1 What is pulsed power

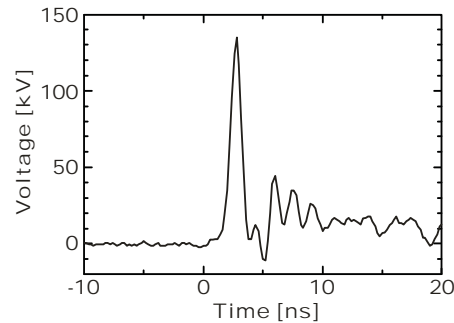

Fig.2 Ns voltage pulse

- Environment**
- Ozone Production
 - NOx Treatment
 - Water Treatment
 - Biomass Fuel Production
- Bioelectrics**
- Growth Control on Plants
 - Stress Response of ER
 - Cancer Therapy by nsPEFs

Fig.3 Pulsed power application



Fig.4 Steamer discharges

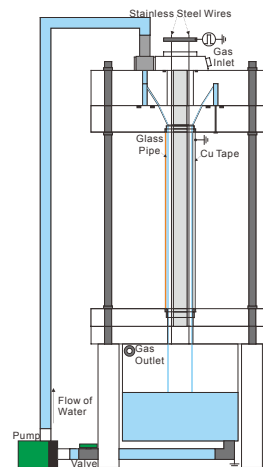

Fig. 5 Water Treatment



Fig.6 Cancer therapy

Content:

Pulse power is the technology of utilizing high power pulses obtained by compressing energy. We focus on green technologies and applications in bioengineering.

Nanosecond pulsed power has been applied on environmental protection technology. It can efficiently produce streamer discharges as which were suitable for discharge-chemical processing. There are the high-efficient ozone production, the exhaust gas treatment of nitrogen oxide (NOx), and the water treatment for persistent substances.

Applications in bioengineering utilize the influence of electric pulses and discharges on biological body. The influences can be controlled by the pulse width (spectrum), various applications can be expected. There are the production technology of micro algae biomass fuel and growth control of plants. We are developing the new cancer therapy and the control method of endoplasmic-reticulum-stress response aiming at prevention of disease, using nanosecond pulsed powers.

Keywords : pulsed power, bioelectrics, pulse electric field

E-mail: simon@tokushima-u.ac.jp

Tel. +81-88-656-7463

Fax: +81-88-656-7463





Faculty of
Science and
Technology
Tokushima University

Optical Fiber Transmission System

Professor Atsushi Takada

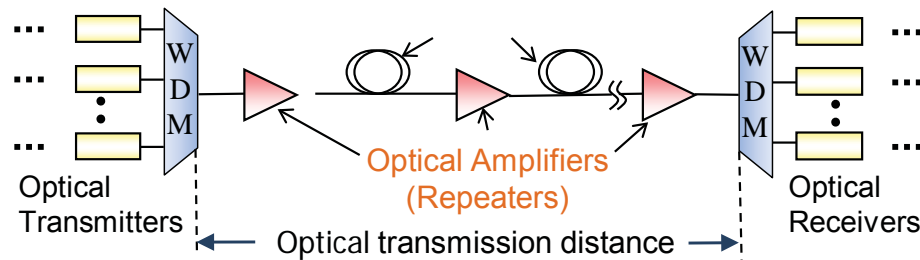
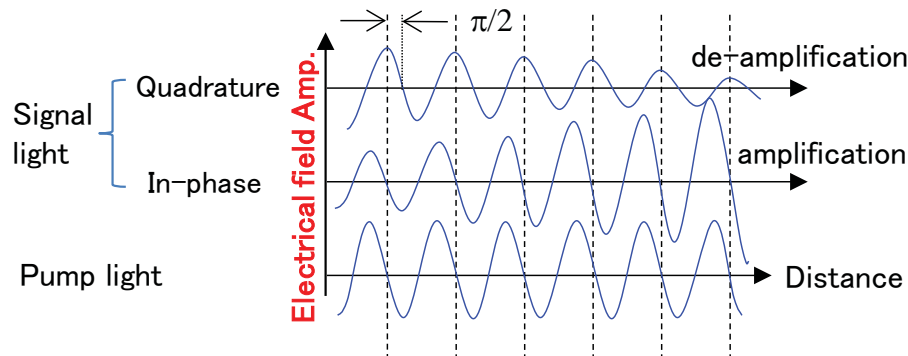
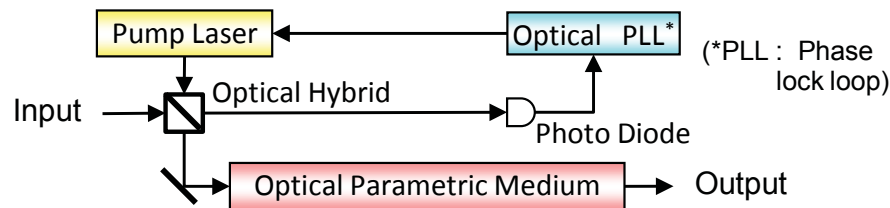

Fig.1 Configuration of backbone optical fiber transmission system



(a) Fundamental operation of PSA



(b) Basic configuration of PSA

Fig. 2 Optical parametric phase sensitive amplifier (PSA)

Content:

The performance of communication network has been drastically enhanced by adopting fiber-optic transmission technologies into the backbone networks and access networks. Recently, the demand for communication capacity is increasing even more, because of popularization of cloud type-application and transportation of ultra-broadband contents such as high-definition moving pictures. The purpose of our laboratory is bringing a significant progress of communication network by introduce novel functionality into the optical communication network.

One of our topics of research is expanding optical transmission distance - capacity in backbone networks (Fig.1) by introducing phase-sensitive optical amplifiers (PSA) (Fig.2) as optical amplifier repeaters. PSAs amplify in-phase and de-amplify quadrature component with reference to phase-locked pump light in parametric amplifiers. Significant extension of optical transmission distance is expected by numerical simulation on transmission system. We have also successfully demonstrated the principles of PSA functionality.

Keywords : optical communication,
optical fiber, optical amplifier
optical signal processing

E-mail: takada@ee.tokushima-u.ac.jp

Tel. +81-88-656-7465





Faculty of
Science and
Technology
Tokushima University

Polarization Control in Photonic Devices with Subwavelength Grating

Professor Yoshiki Naoi

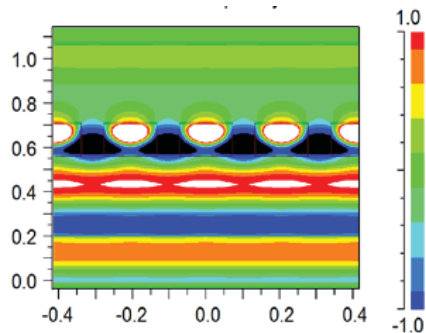
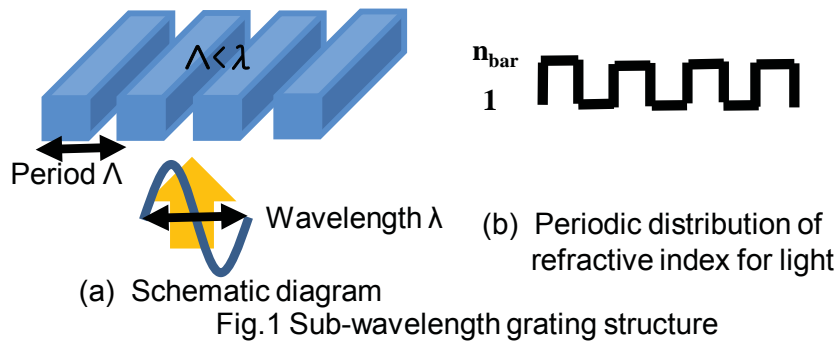

Fig.2 Electrical field distribution for TM light by FDTD theory (in case of $\lambda/\Lambda=1.8$)

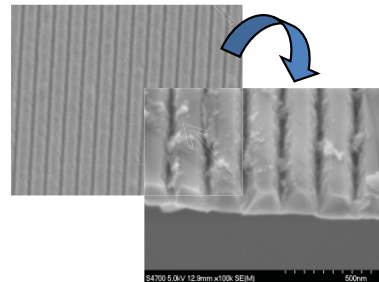

Fig.3 Fabricated sub-wavelength grating on UV-LED surface

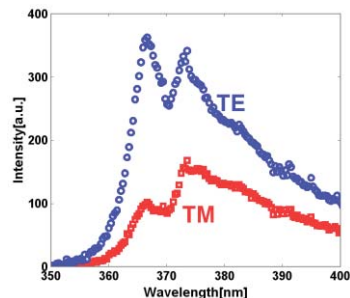

Fig.4 Emission spectra from UV-LED

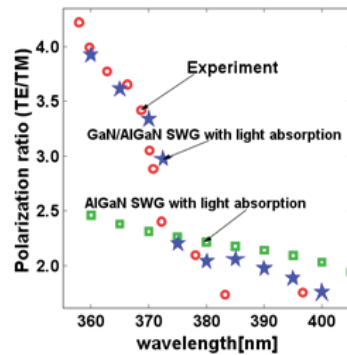

Fig.5 Polarization ratio from UV-LED with sub-wavelength grating

Content:

Highly polarized UV emission devices were expected to develop the applications, such as high resolution imaging, high sensitive sensors, etc. The compact polarization control device with high transmittance is required in order to develop integrated device for these applications.

One of the candidates to overcome the issue is the device using high contrast dielectric subwavelength grating (SWG) structure. In SWG, the pitch of the grating is shorter than the wavelength of incident light. The Bloch like eigen-modes within SWG region resulting from the spatial periodicity of refractive index distribution interacts with incident light. As a result, the desirable optical characteristics such as broadband high reflectivity and polarization sensitivity are obtained with optimal structures.

We have investigated the polarization characteristics of AlGaIn-based UV-LED with SWG fabricated on the top of LED surface, and demonstrated the feasibility of high polarized UV-LED grown on c-plane sapphire.

Keywords : photonic device, sub-wavelength grating, polarization control, nano device

E-mail: naoi@ee.tokushima-u.ac.jp

Tel. +81-88-656-7447

Fax: +81-88-656-7447

HP: <http://cms-ldap.db.tokushima-u.ac.jp/DAV/person/S10703/WEB/index.html>



Faculty of
Science and
Technology
Tokushima University

Engineering Applications of Chaos

Professor Yoshifumi Nishio

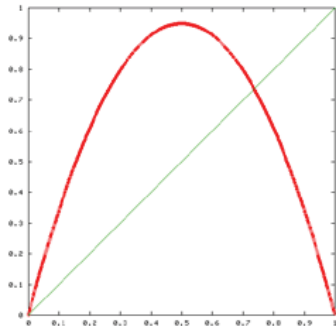

Fig. 1: Logistic map, one of the most famous one-dimensional map generating chaos.

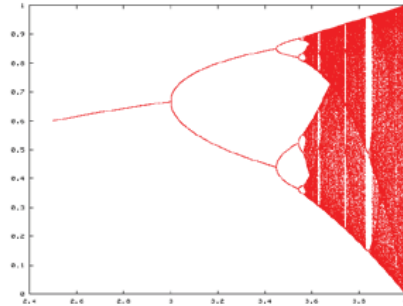

Fig. 2: One-parameter bifurcation diagram of the Logistic map.

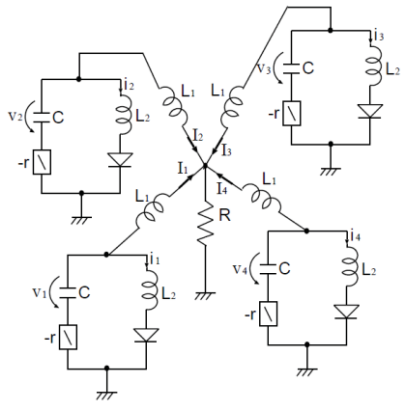

Fig. 3: Four autonomous chaotic circuits coupled by one resistor.

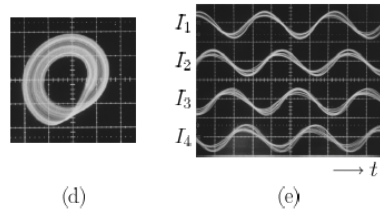
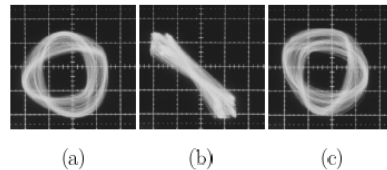

Fig. 4: Four-phase quasi-synchronization of chaos observed from the circuits in Fig. 3.

Content:

1. Chaos Cryptosystems

Sensitive dependence of chaos on initial conditions and parameters is exploited for various security issues.

2. Chaos Communication Systems

Continuity of chaotic sequences generated from an identical chaotic map is exploited to recover data correctly.

3. Complex Networks

Various synchronization phenomena in coupled chaotic circuits are good models of various complex networks.

4. Nonlinear Time Series Analysis

Chaos analysis is utilized to predict a trend of nonlinear time series or to diagnose medical signals.

5. Data Mining

Self-organizing feature of artificial neural networks is exploited to carry out clustering of various data.

Keywords: chaos, chaos cryptosystems, chaos communication systems, complex systems, nonlinear time series analysis

E-mail: nishio@ee.tokushima-u.ac.jp

Tel. +81-88-656-7470

Fax: +81-88-656-7471

HP : <http://nlab.ee.tokushima-u.ac.jp/nishio.htm>





Diversity of Electrical Energy Resources in a Reliable Grid

[Keywords: Smart Grid, Reliability, Stability, Power Quality] Professor Masahide Hojo

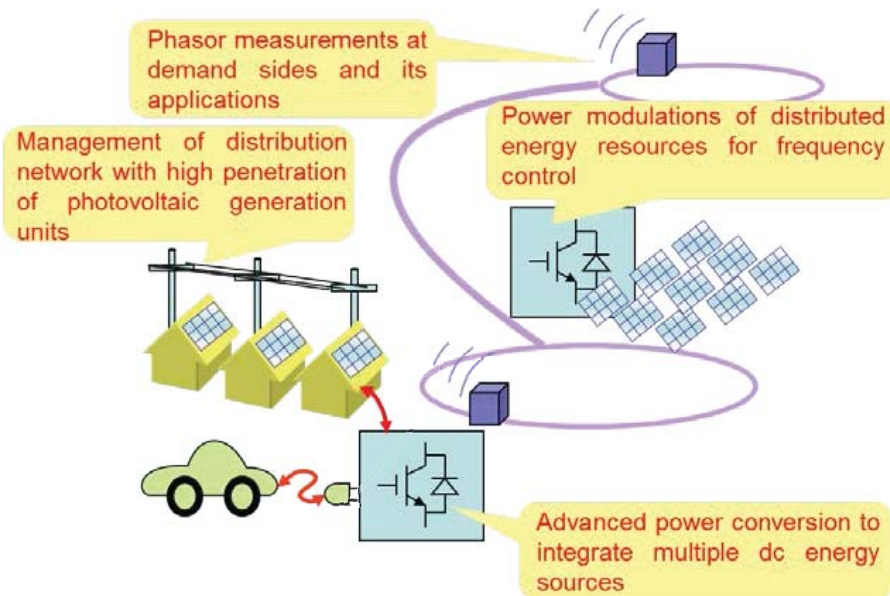

Fig. 1 My major researches.

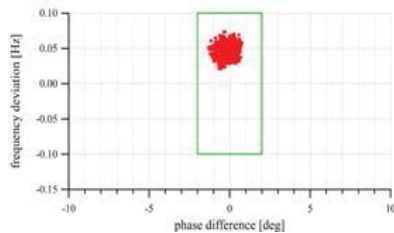

Fig. 2 Grid monitoring.

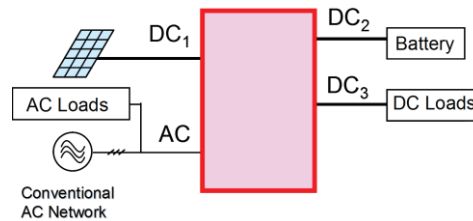

Fig. 3 Dc sources integration.

Topics

1. [Phasor measurements at demand sides and its applications](#)
Developing an online monitoring of power system by multiple phasor measurement units with monitoring voltages at the outlets on the wall.
2. [Management of distribution network with high penetration of photovoltaic generation units](#)
Investigating reasonable voltage regulation on high and low voltage distribution lines by cooperation of photovoltaic generation units and other apparatus.
3. [Advanced power conversion to integrate multiple dc energy sources](#)
Integrating multiple dc voltage terminals to connect solar cells, batteries and loads easily, based on multilevel converter topology with flying capacitors.
4. [Series-connected dc-dc converter for multi-end dc power transmission](#)
Developing a high frequency dc-dc power converter in series with a dc power transmission or distribution line to provide multi -ends.
5. [Power modulations of distributed energy resources for frequency control](#)
Developing a voltage phasor modulation of grid-connected converters to regulate the system frequency as much as possible.

Keywords: Smart Grid, Reliability, Stability,
Power Quality

Field: Power system and power electronics

E-mail: hojo @ ee.tokushima-u.ac.jp

Tel/Fax. 088-656-7452





Faculty of
Science and
Technology
Tokushima University

Engineering Applications of Intelligent Information Processing and Control Technique

Professor Takashi Yasuno



Wind Turbine



Power assist suit



Electric wheelchair

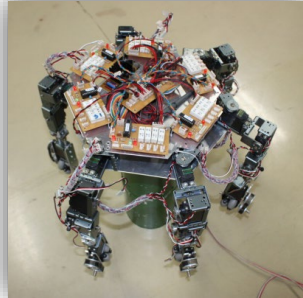

Multi-legged robot



Electric Vehicle



Pesticide spraying robot



Environmental monitoring

Content:

In recent years, demands for higher performance and added value in industrial and life support equipment that is designed to coexist with humans has been growing. In order to satisfy these demands, we are conducting research on the application of intelligent information processing technology based on a bio-inspired approach. The main research themes are as follows, and we are promoting the realization of the elemental technologies obtained in the research process through collaboration research.

- ◆ Prediction of wind and solar power output based on weather prediction models
- ◆ Control of automatic driving systems and cooperative control of swarm mobile robots
- ◆ Motion control for legged robots and robot manipulators
- ◆ Safe driving support system for electric wheelchairs
- ◆ Development of various agricultural support robots

Keywords: intelligent control, robot, wind energy and photovoltaic power generation, rehabilitation system

E-mail: yasuno.takashi@tokushima-u.ac.jp

Tel. +81-88-656-7458

Fax: +81-88-656-7458

HP : <https://www-sky.ee.tokushima-u.ac.jp>





Modeling of Dynamical Brain Networks by Coupled Oscillatory Systems

Associate Professor Yoko Uwate

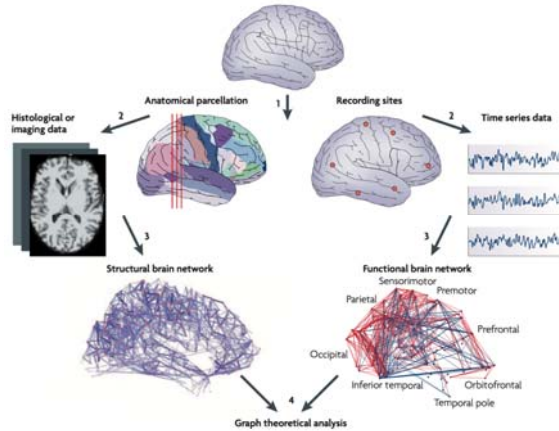

Fig. 1 Structural and functional brain networks

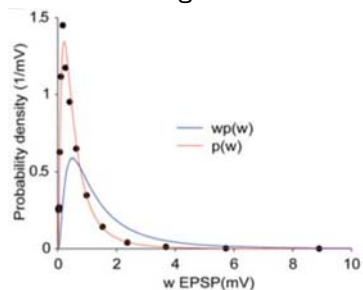

Fig. 2 Heavy tail distribution

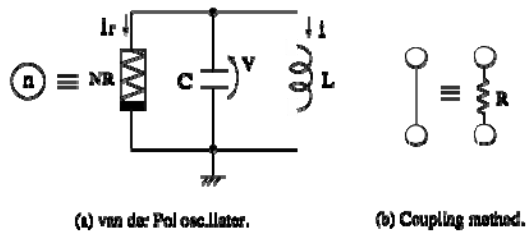

Fig. 3 van der Pol oscillator

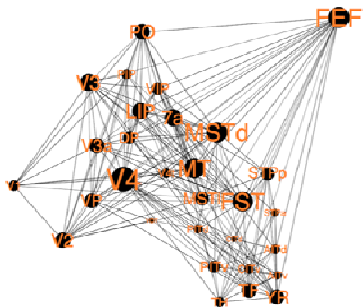

Fig. 4 Brain network model
of macaque visual cortex

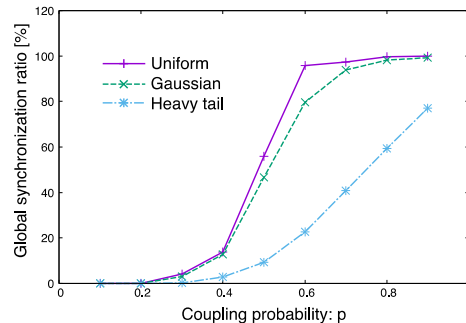

Fig. 5 Global synchronization

Content:

1 Introduction

Recently, structural and functional brain network have been made clear (Fig. 1). And, several research group have reported that the synaptic connection has heavy tail distribution as shown in Fig. 2. In this project, we investigate synchronization of brain network model of macaque visual cortex with heavy tail coupling distribution.

2 Proposed system and results

Figure 4 shows brain network model of macaque visual cortex. the node of network model is expressed by van der Pol oscillator (Fig. 3). Figure 4 shows the simulation results of global synchronization. The network with heavy tail distribution synchronized to avoid global synchronization.

3 Future works

Investigation of more large brain network and make clear the relationship between synchronization and high-function of brain are our future works.

Keywords : coupled oscillators, synchronization,
clustering

E-mail: uwate@ee.tokushima-u.ac.jp

Tel. 088-656-7662

Fax: 088-656-7471

HP : <http://nlab.ee.tokushima-u.ac.jp/uwate.htm>





Biological sound-based medical diagnosis system

Associate Professor Takahiro Emoto



Fig.1 A sample of snoring sound recordings



Fig.2 A sample of bowel sound recordings

Content:

There are a lot of patients who suffer from chronic disease (e.g. obstructive sleep apnea and a bowel disease etc.). Recently the prevalence of these diseases is likely to be increasing in many countries. Polysomnography (PSG) and endoscopic test have been used for the diagnosis. However these tests are inconvenience and expensive. Our research group hypothesizes that the information on these diseases should be embedded in biological sounds (e.g. snoring and bowel sounds) obtained from the patients. Biological sounds can be simply acquired via non-contact and/or non-invasive measurements. The target of our study is to develop the automated diagnosis system based on the analysis of biological sounds. We are currently in the process of developing new sophisticated techniques for future medical applications. Biological sound-based techniques can be expected to provide an attractive alternative to the conventional test for chronic disease.

Keywords: Biomedical signal processing and bio-medical instrumentation

E-mail: emoto@ee.tokushima-u.ac.jp

Tel. +81-88-656-7476

Video coding algorithm and its VLSI architecture

Associate Professor Tian Song

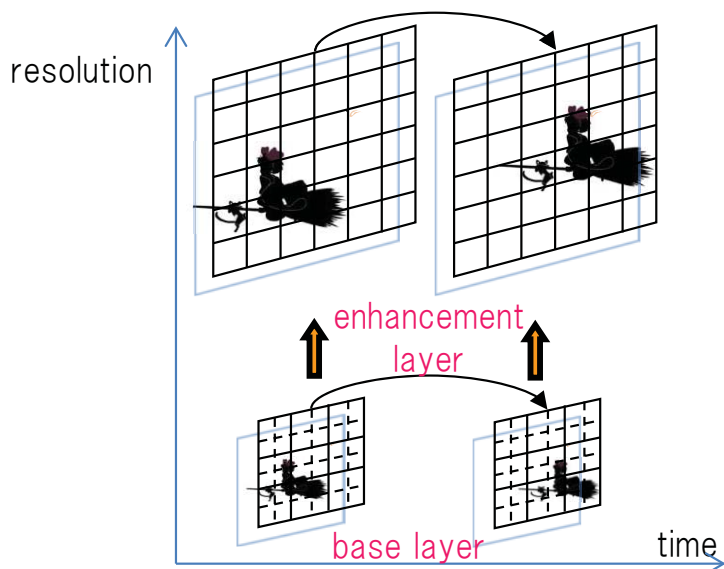

Fig.1: H.264/SVC inter layer prediction

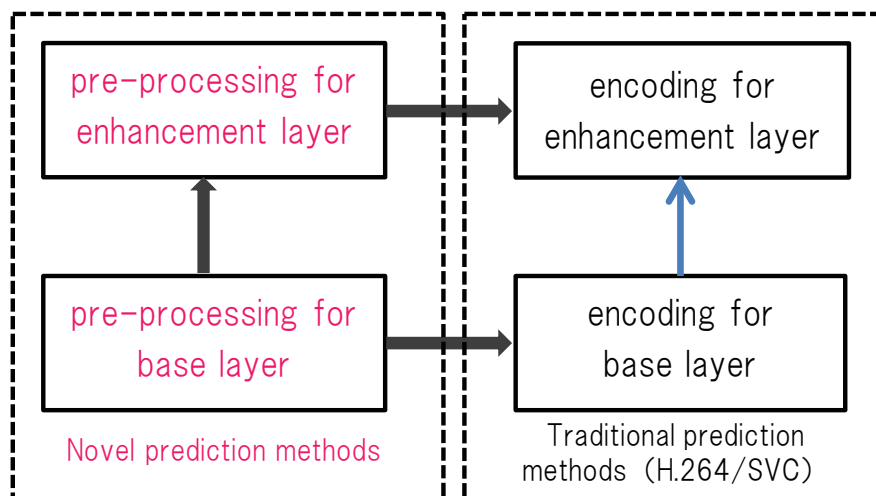

Fig.2: The proposed coding structure

With the widely spread of video applications, novel coding algorithms which can answer many kinds of emerging demands are highly required. Our research group is devoting to propose good ideas concerning the following themes.

1. Improvements of the algorithms of HEVC and its low complexity and low power VLSI architecture for the next generation applications which are over 4K resolutions. The algorithms and architectures are concerning the intra coding, motion estimation, and deblocking filter.
2. Scalable video coding algorithms which are suitable for high resolution applications. We will make full use of the high correlations between base layer and enhancement layer to propose new algorithms to improve the coding efficiency.
3. Highly parallel processing video coding algorithms on many core platforms. Most of traditional coding algorithms utilize the coding parameters of adjacent blocks to improve coding efficiency. However, this coding structure has essential demerit for parallel processing. As shown in Fig.2, our motivation is to find new coding structure which can achieve higher parallel coding performance.

Keywords : H.265/HEVC, Scalable Video coding(SVC), Parallel Video Coding

E-mail: tiansong@ee.tokushima-u.ac.jp

Tel. 088-656-7484

Fax: 088-656-7471



Faculty of
Science and
Technology
Tokushima University

Generation, Diagnosis and Applications of Discharge Plasma

Associate Professor Kenji Teranishi

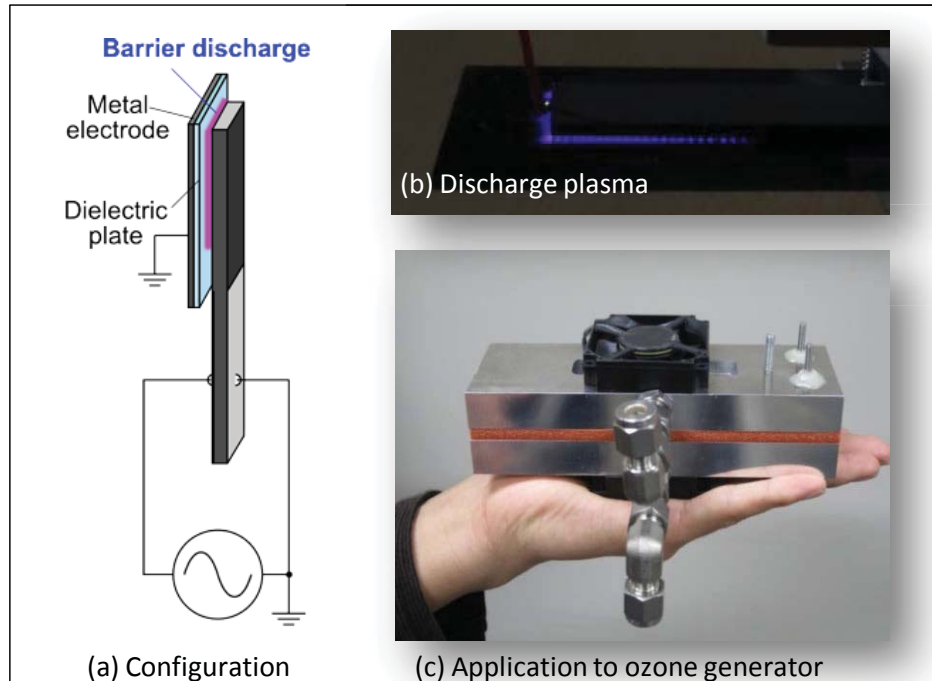

Fig. 1 Compact plasma reactor using piezoelectric device and its application

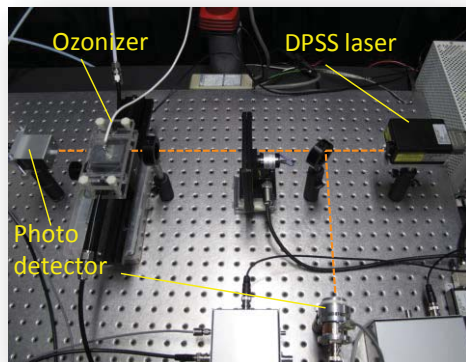

Fig. 2 *In-situ* O₃ measurement by laser optical absorption

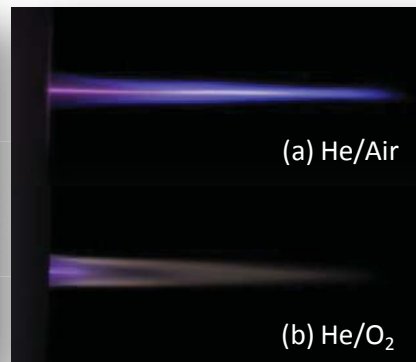

Fig. 3 SGF Plasma jet

Content:

Discharge plasma reactors consisting of a massive high voltage generator and discharge electrodes are more likely to become large-scale system. We have proposed and studied various types of compact plasma reactors using piezoelectric devices. Piezoelectric transformers (PTs) that act as compact high-voltage generator have been widely embedded in a backlight inverter for LCDs. Our proposed plasma reactors feature compact configurations because the devices serve as both high-voltage source and discharge electrode. Non-thermal plasmas, such as corona discharge, glow discharge and dielectric barrier discharge (Fig. 1(a)(b)) can be produced using the plasma reactors. Several applications of the plasma reactors to ozone generators (Fig. 1(c)) and vacuum ultraviolet light source have been demonstrated.

We have also promoted actively other research in generation, diagnosis and applications of non-thermal atmospheric pressure plasma, including *in-situ* measurement of ozone density inside DBD ozone generator (Fig. 2) and surrounding gas-fed (SGF) plasma jet (Fig. 3).

Keywords : Dielectric barrier discharge, ozone, plasma jet

E-mail: teranishi@ee.tokushima-u.ac.jp

Tel. +81-88-656-7454

Fax: +81-88-656-7454

<http://pub2.db.tokushima-u.ac.jp/ERD/person/155803/profile-ja.html>





Faculty of
Science and
Technology
Tokushima University

Physics and application of femtosecond laser irradiation

Associate Professor Takuro Tomita

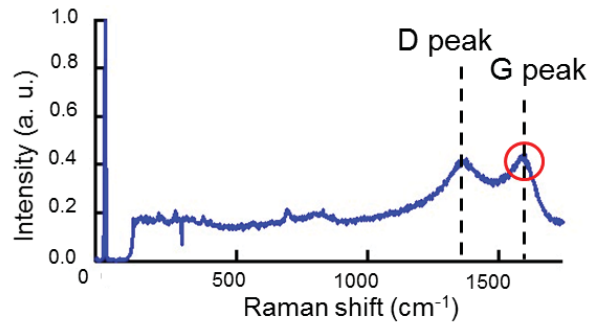

Fig.1 : Raman spectra with femtosecond laser irradiation on the interface between nickel and silicon carbide

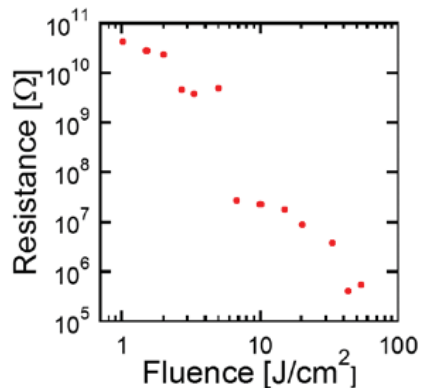
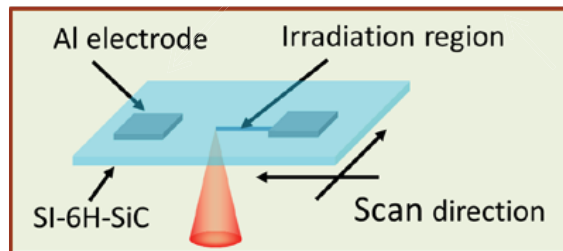

Fig.2 : Electrical conduction control by fs laser modification

The material modification due to the femtosecond laser irradiation on wide bandgap semiconductors has been studied. The spontaneous formation of nano-periodic structures and the amorphization due rapid heating and cooling process occurs after femtosecond laser irradiation. Wide bandgap semiconductors can be processed through the multi-photon process because of their transparency to femtosecond laser beam.

Fig. 1 shows Raman spectra after the femtosecond laser irradiation on the interface between silicon carbide and nickel. D and G bands due to carbon was observed, and this indicates that the carbon atom reached the nickel surface.

Fig. 2 shows the schematic of electrical conduction control by fs laser modification. The femtosecond laser beam is irradiated between two metal contacts on semiconductor. With increasing the irradiation fluence, the local electrical conductivity abruptly decreased at the threshold fluence.

Keywords : femtosecond laser, ablation

E-mail: tomita@tokushima-u.ac.jp

Tel. +81-88-656-7445

Fax: +81-88-656-7445

HP : <http://pub2.db.tokushima-u.ac.jp/>

ERD/person/ 82121/profile-en.html





Faculty of
Science and
Technology
Tokushima University

Crystal Growth and Device Applications of Various Semiconductors

Associate Professor Katsushi Nishino

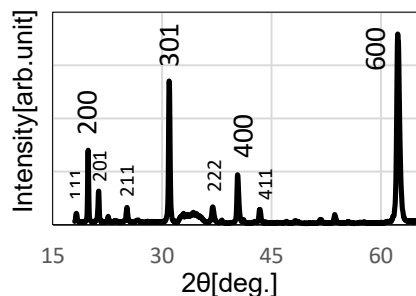

Fig.1 XRD pattern of BaSi₂ thin film

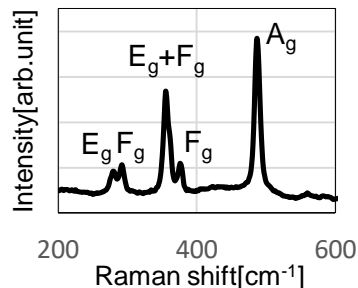

Fig.2 Raman spectrum of BaSi₂ thin film

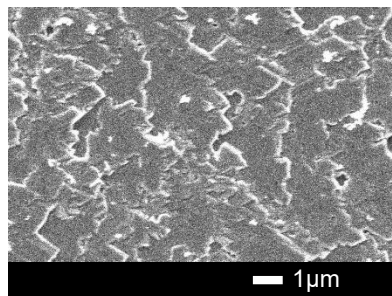

Fig.3 Surface SEM image of β-Ga₂O₃ thin film

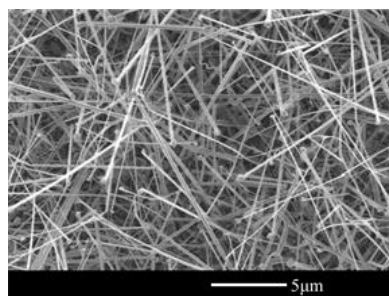

Fig.4 SEM image of β-Ga₂O₃ nanowires

We are studying on crystal growth and device applications of two kinds of semiconductors.

1. BaSi₂ has suitable properties for thin film solar cells, such as a bandgap, high absorption coefficients, and long minority carrier diffusion length. We grow BaSi₂ thin films on Si(100) substrates by conventional vacuum evaporation. Obtained films are a-plane oriented (Fig.1) and of high quality estimated by Raman scattering spectroscopy as shown in Fig.2. We are currently investigating the crystal quality, electrical and optical properties in detail for solar cell applications.

2. Ga₂O₃ is a widegap semiconductor and is expected as a material for high-power devices and various kinds of sensors. Among some polymorphs of Ga₂O₃, we grow thin films and nanowires of most thermally stable β-phase by a direct synthesis method, which utilizes direct reaction of Ga and O₂ gas. Fig.3 shows a surface SEM image of a β-Ga₂O₃ thin film. The film has the step-terrace structure on the surface and is high quality with enough thickness. β-Ga₂O₃ nanowires with a diameter of about 100nm and a length of 10μm or longer can be grown on c-plane sapphire and glass substrates as shown in Fig.4.

Keywords: BaSi₂, Ga₂O₃, Nanowire

E-mail: knishino@tokushima-u.ac.jp

Tel. +81-88-656-7464

Fax: +81-88-656-7464



Design for testability of VLSI chips

Associate Professor Hiroyuki Yotsuyanagi

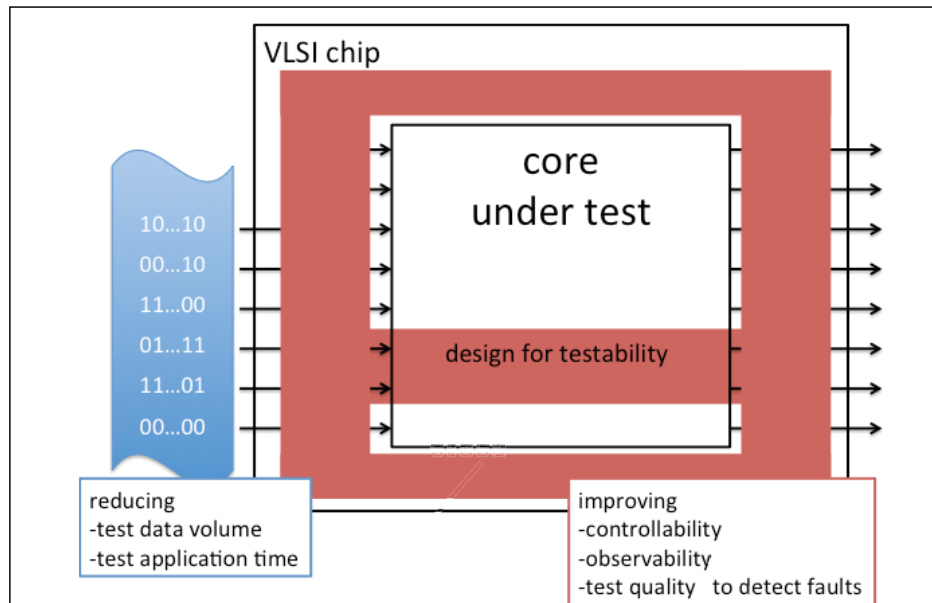

Fig.1 overview of design for testability

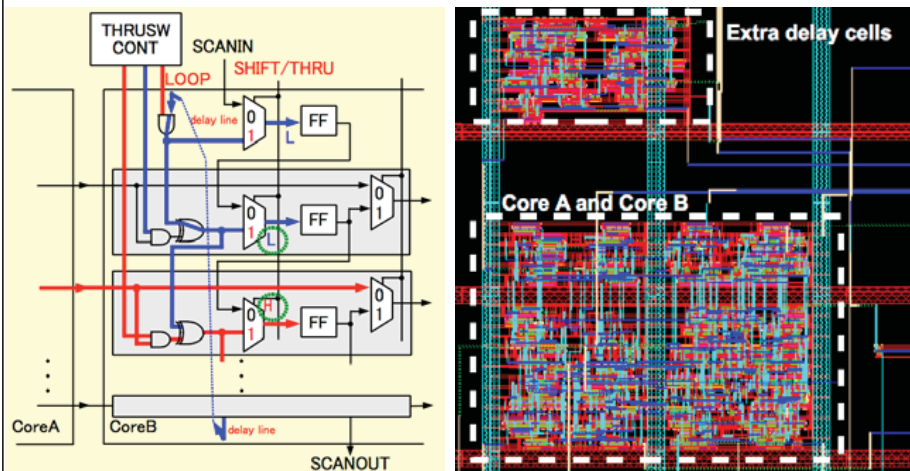

Fig.2 Boundary scan with TDC

Fig.3 layout of an experimental chip

Content:

In recent highly integrated VLSIs, cost of testing is a major problem. To alleviate the difficulty in testing, design for testability techniques are widely used. In our research lab, we develop methods for reducing test cost such as test data volume, test application time, area overhead of test circuit, and for improving test quality especially in delay testing. One of the techniques is design for testability method for small delay faults using time-to-digital converter embedded in boundary scan called TDCBS, shown in the figures. The boundary scan cells are modified to be able to form a time-to-digital converter that is utilized for detecting delay. Using this architecture, defects like opens and shorts can be detected as extra delay caused by such defects even if the delay is small and cannot be detected by conventional logic test. The feasibility of the proposed methods is estimated by both simulation and experiments of fabricated chips.

Keywords : design for testability, VLSI testing, delay faults, test cost reduction

E-mail: h.yotsuyanagi@tokushima-u.ac.jp

Tel. +81-88-656-9183

Fax: +81-88-656-9183

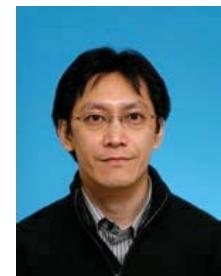



Faculty of
Science and
Technology
Tokushima University

Development of a measurement device for blood flow velocity in the carotid artery

Associate Professor Masatake Akutagawa

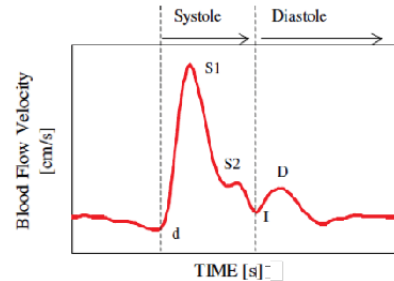

Fig 1. Prototype of a measurement device for blood flow velocity (BFV) and typical waveform of BFV in the carotid artery

Young group (age ranges: 20-38) → Middle group (age ranges: 39-57) → Older group (age ranges: 58-76)

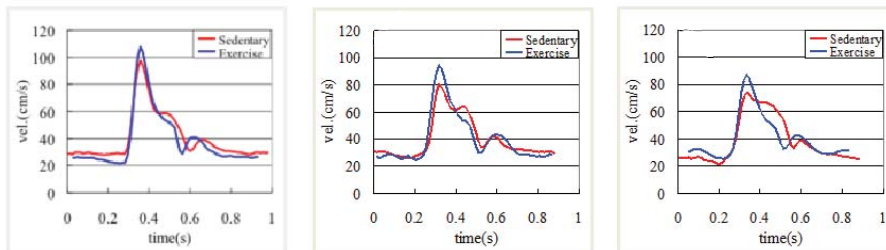

Fig 2. Change of BFV waveforms with age and exercise

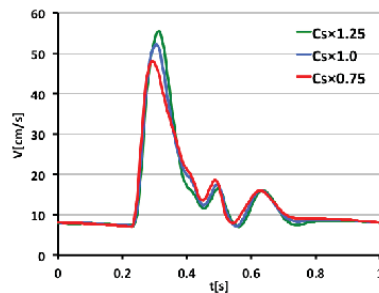

Fig 3. Change of BFV waveforms for different compliance of the arteries (computer simulation)

Content:

According to the vital statistics from Ministry of Health, Labour and Welfare, 33% of Japanese are died by diseases related to the circulatory system. It is well-known that diet modification and an appropriate exercise are effective to prevent these diseases. If we have a portable device which can evaluate the circulatory system and exercise habit, it is expected to suppress these diseases and medical care costs.

We have developed a portable measurement device (Fig. 1) for blood flow velocity (BFV) and investigated the relationship to various conditions for hundreds of subjects. As results of them, BFV waveforms show remarkable trends corresponding to aging and exercise habit as shown in Fig. 2. These trends may reflect extent of atherosclerosis. We confirmed that they are caused by compliance of the arteries by use of the multi-branched arterial segment as shown in Fig.3.

Keywords : Ultrasound doppler, atherosclerosis, blood flow velocity

E-mail: makutaga@ee.tokushima-u.ac.jp

Tel. +81-88-656-7477

Fax: +81-88-656-7477





Faculty of
Science and
Technology
Tokushima University

Study on Photocatalytic Thin films for Environmental Conservation and New Energy Production Based on Plasma Electronics

Associate Professor Retsuo Kawakami

<図表>

Photocatalytic Thin Film

Environmental
conservation



earth

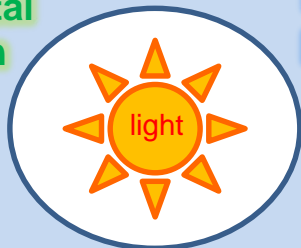

TiO₂ thin film

New energy
production



human

Semiconductor Plasma Electronics

PVD sputtering

DBD plasmas

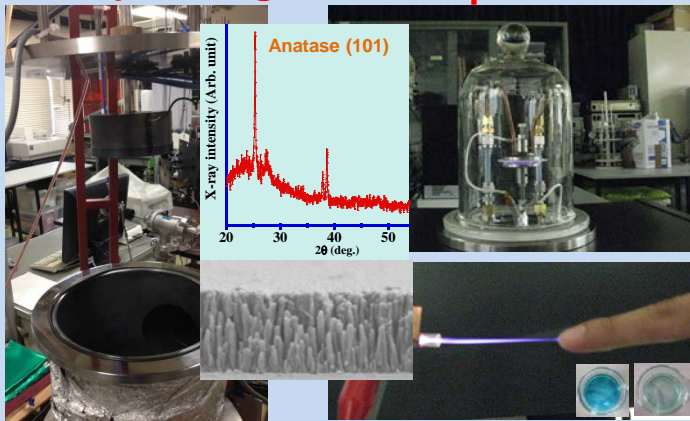

Content:

Photocatalyst has been attracting much attention as a material for environmental conservation and new energy production. The advantage is that the photocatalytic activity is activated semipermanently while the surface is irradiated with light. TiO₂ is a leading candidate as the photocatalyst. This reason is that the photocatalytic activity is activated easily under irradiation with near UV-visible light and that TiO₂ is hardly dissolved by its own photocatalytic activity. Since TiO₂ is an inorganic compound, TiO₂ is harmless for human and earth, and is stable in aqueous media and reactive gas. The thin films, rather than the powders, are required from the viewpoint of the practical application such as large area coating. The photocatalytic activity induced by use of the thin films, however, is less enhanced than that induced by use of the powders.

We have been studying TiO₂ thin films with excellent photocatalytic activity by using a magnetron facing target sputtering deposition device developed by our group. The characteristic of the deposition device is that the anatase thin films is fabricated without heating the substrate and performing the post-annealing. We have also been studying the anatase films treated by using an atmospheric pressure plasma device developed by our group, in order to further enhance the original photocatalytic activity. The characteristic of the treatment device is that the surface treatment is performed easily in the absence of expensive vacuum pumps.

Keywords: Photocatalyst, Wide band-gap semiconductor, Plasma electronics

E-mail: retsuo@ee.tokushima-u.ac.jp

Tel. +81-88-656-7441

Fax: +81-88-656-7441





Video codec extension algorithm and its VLSI architecture using machine learning

Assistant Professor Takafumi Katayama

■ Prediction pixels generation using machine learning

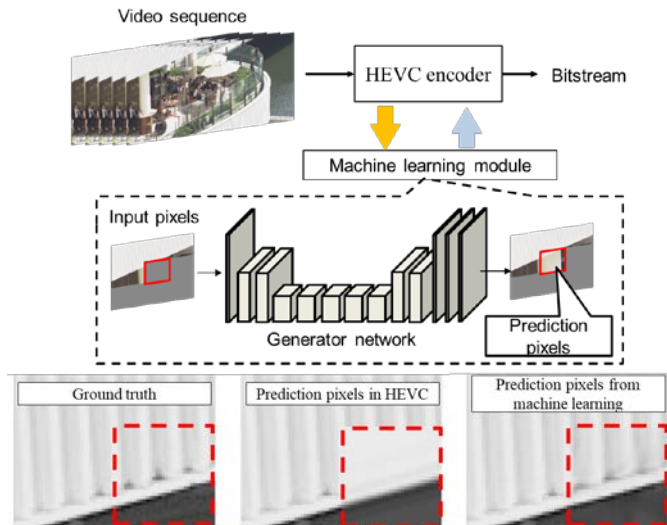

Fig. 1 Comparison of a conventional prediction pixels and proposed

■ LSI design of neural network for image processing

Represent complex neural network with ODE (Ordinary Differential Equation)

➡ Applicable to image processing

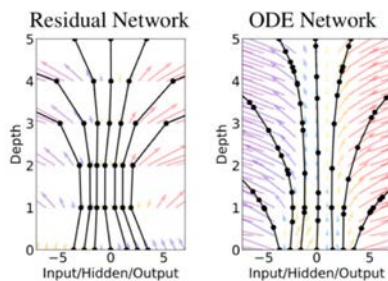

Fig.2 ResNet and ODE Net structure



Fig. 3 FPGA(PYNQ-Z1)

Content:

As the AI / IoT environment spreads to society, video will continue to play a major role as a technique of information transmission. In order to provide accurate and detailed moving images, video codec technology is implemented to various familiar devices. In the next generation codec technology, because parallel processing is difficult, an application to ultra-high resolution becomes more and more challenging. In this work, HEVC encoder is divided into two parts, an analysis circuit (machine learning module) and an encoding circuit (encoder) in order to establish a new encoding structure with high compression while achieving easy hardware implementation (Fig. 1). Predicted pixels value close to ground truth can be generated by embedding a machine learning module. In the future, we will implement FPGA of ODE Network to establish real-time processing of the image generation network (Fig. 2, 3).

By completing this work, we aim to make a significant contribution to the next-generation social infrastructure environment called AI, IoT, and 5G.

Keywords: Video coding, Machine learning, LSI design

E-mail: t.katayama@tokushima-u.ac.jp

Tel. 088-656-7482

Fax: 088-656-7471

HP : <http://pub2.db.tokushima-u.ac.jp/ERD/person/350321/profile-ja.html>



■ Prediction pixels generation using machine learning

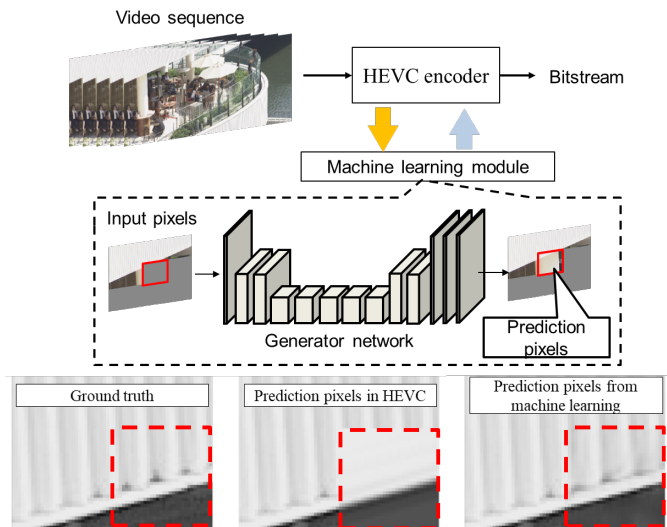

Fig. 1 Comparison of a conventional prediction pixels and proposed

■ LSI design of neural network for image processing

Represent complex neural network with ODE
(Ordinary Differential Equation)

➔ Applicable to image processing

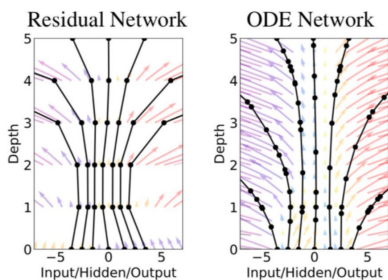

Fig.2 ResNet and ODE Net structure



Fig. 3 FPGA(PYNQ-Z1)

Content:

As the AI / IoT environment spreads to society, video will continue to play a major role as a technique of information transmission. In order to provide accurate and detailed moving images, video codec technology is implemented to various familiar devices. In the next generation codec technology, because parallel processing is difficult, an application to ultra-high resolution becomes more and more challenging. In this work, HEVC encoder is divided into two parts, an analysis circuit (machine learning module) and an encoding circuit (encoder) in order to establish a new encoding structure with high compression while achieving easy hardware implementation (Fig. 1). Predicted pixels value close to ground truth can be generated by embedding a machine learning module. In the future, we will implement FPGA of ODE Network to establish real-time processing of the image generation network (Fig. 2, 3).

By completing this work, we aim to make a significant contribution to the next-generation social infrastructure environment called AI, IoT, and 5G.

Keywords: Video coding, Machine learning, LSI design

E-mail: t.katayama@tokushima-u.ac.jp

Tel. 088-656-7482

Fax: 088-656-7471

HP : <http://pub2.db.tokushima-u.ac.jp/ERD/person/350321/profile-ja.html>



Faculty of
Science and
Technology
Tokushima University

Intelligent Control of Swarm Robots

Research Associate, Hiroshi Suzuki



Swarm robots

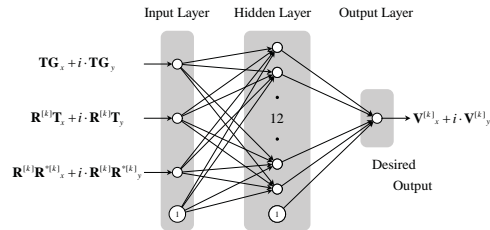

Complex-valued NN

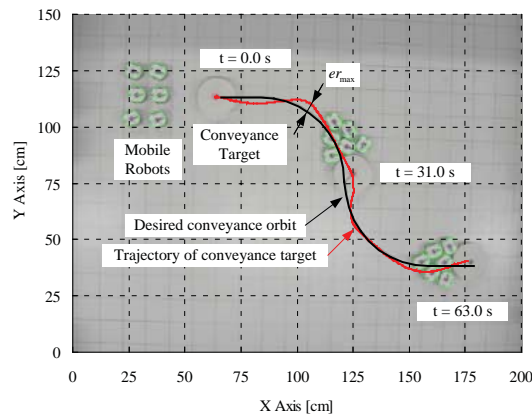

Experimental Result

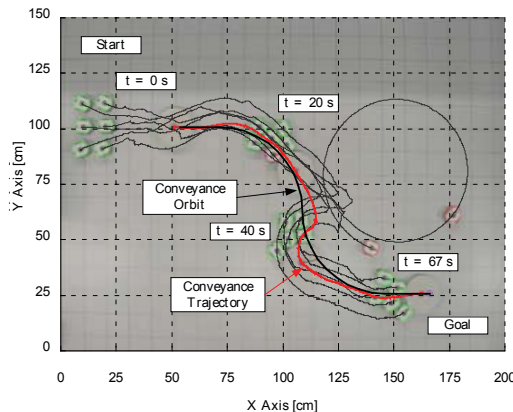

Fault tolerance

Content:

The swarm robotics has a problem on the control system design cause of voluminous measured information and motion patterns. Therefore, we propose the control system which uses soft computing scheme e.g. neural networks (NN), fuzzy system and genetic algorithm (GA).

The left figures are our proposed cooperative control system for swarm robots using complex-valued NN (CVNN) and GA. The CVNN can treat a two dimensional position information and adaptable for control of mobile robots. The system inputs a position information for CVNN and outputs a velocity vector and parameters of CVNN are optimized by GA. We confirmed a tracking performance for desired conveyance orbit, and a fault tolerance performances of some robot's breakdown.

Moreover, we propose an extraction system of human operation skills using datamining method and analyze a behavior of robots basis on simple motion rules.

Keywords : Swarm robotics, Machine learning,

Cooperative control

E-mail: suzuki.hiroshi@tokushima-u.ac.jp

Tel. +81-88-656-7455

Fax: +81-88-656-7455

HP : <http://www-sky.ee.tokushima-u.ac.jp/>





Faculty of
Science and
Technology
Tokushima University

Highly Sensitive Optical Refractive Index Sensor with Meta-Surface

Assistant Professor Yuusuke, Takashima

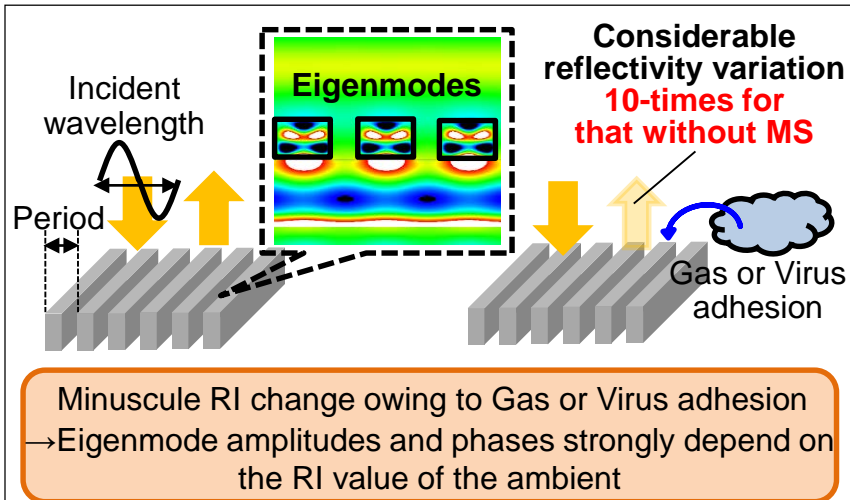

Fig.1 Operation principle of RI sensing with meta-surface

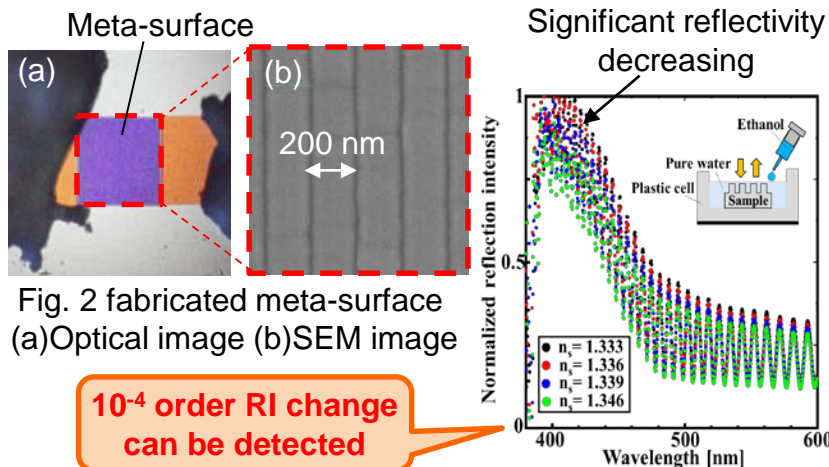

Fig. 2 fabricated meta-surface
(a)Optical image (b)SEM image

10⁻⁴ order RI change can be detected

Fig. 3 Dependence of reflectivity on the ambient RI value n_s

Content:

Optical refractive index (RI) sensors is highly desirable for many applications, such as gas-detection and bio-sensing. For these applications, high sensitivity and compactness are required.

Highly sensitive compact RI sensor was demonstrated with periodic meta-surface (MS), whose dimension is smaller than the incident wavelength (Fig.1). The amplitude and phase of the optical eigenmodes resulting from the subwavelength periodicity of the MS considerably depend on the ambient RI. As a result, highly sensitive RI sensing can be realized.

We fabricated the MS on GaN substrate (Fig. 2). The Blue-violet light is strongly reflected owing to the structure. Utilizing the eigenmodes in the MS, 10⁻⁴ order RI can be experimentally detected with very compact and simple optical system, as shown in Fig. 3. Our sensor is very suitable for the integrated devices for gas- and bio-sensing due to its high sensitivity and compactness

Keywords : Meta-surface, Subwavelength, Refractive index sensor

E-mail: takashima@tokushima-u.ac.jp

Tel. <電話番号 +81-88-656-7438>

Fax: <fax番号 +81-88-656-7438>

